



REGIONAL ANESTHESIA

PRODUCT CATALOG

Reach your targets quicker

Thanks to regional anesthesia

OPTIMIZE PROCESSES

Regional anesthesia is an essential part of pain therapy, as across several interventions, it offers clear advantages when compared to general anesthesia.¹ For regional anesthesia to become an important part of the peri-operative process, there are some prerequisites to consider, like the relevant indications, skilled personnel and the necessary internal processes at the clinic.

The rapid growth of use of regional anesthesia and the numerous publications on the topic are both a testament to how regional anesthesia can have a positive impact on both patient outcome and on efficiencies for the clinic.^{2,3}

WITH REGIONAL ANESTHESIA

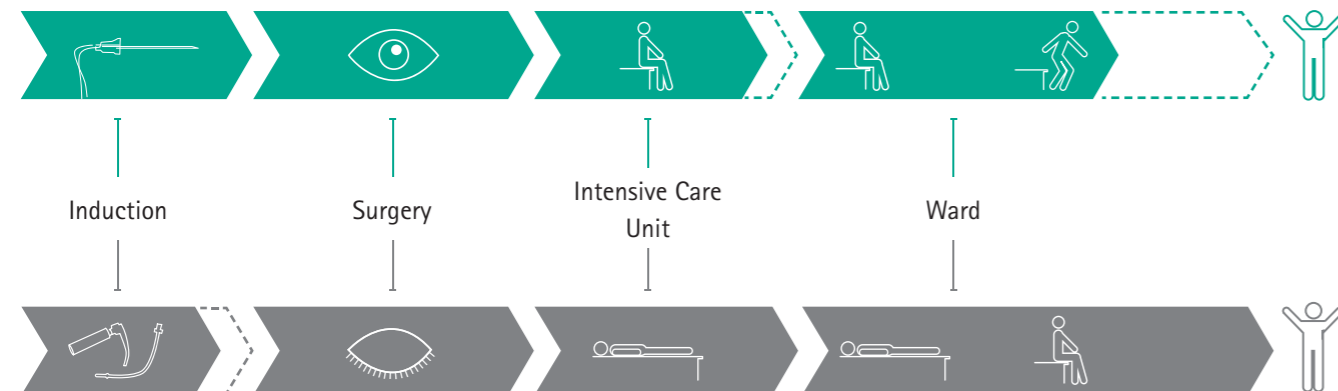

WITHOUT REGIONAL ANESTHESIA

COMPARING TWO POTENTIAL INTERVENTIONS WITH AND WITHOUT REGIONAL ANESTHESIA:

Looking holistically across the patient pathway, the establishment of regional anesthesia processes appears to be a favorable investment. When regional anesthesia is used, patients see better outcomes, faster mobilization and consequently earlier discharge.^{4,5}

Content

REGIONAL ANESTHESIA

NRFit® connecting what belongs together | product highlights

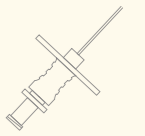

REGIONAL ANESTHESIA WITH NRFIT®

SPINAL ANESTHESIA

Spinocan® | Pencan® | Atraucan® | Spinal Introducer Needle

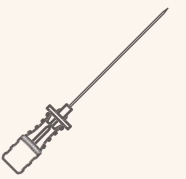

SPINAL ANESTHESIA

EPIDURAL ANESTHESIA

Perican® | Perican® Paed | Epican® Paed
Perifix® Epidural Catheter | Accessories

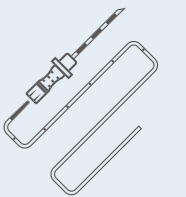

EPIDURAL ANESTHESIA

COMBINED SPINAL & EPIDURAL ANESTHESIA

Espocan®-Sets

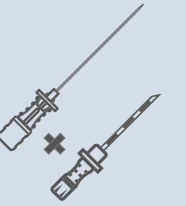

COMBINED SPINAL AND EPIDURAL ANESTHESIA

PERIPHERAL NERVE BLOCKS

Stimuplex® A | Stimuplex® Ultra 360 | Ultraplex® 360 | Contiplex® C |
Contiplex® S Ultra 360® | Contiplex® Tuohy Ultra 360® | Contiplex® D

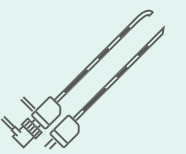

PERIPHERAL NERVE BLOCKS

ULTRASOUND GUIDANCE

Xperius® | Onvision® | EZCOVER®

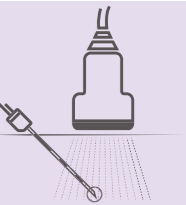

ULTRASOUND GUIDANCE

ELASTOMERIC PUMP SYSTEMS

ON-Q®-Pump



ELASTOMERIC PUMP SYSTEMS

CONTINUOUS WOUND INFUSION

ON-Q®-System | ON-Q® Catheter | Accessories for ON-Q®-Systems



CONTINUOUS WOUND INFUSION

Pain therapy with Regional Anesthesia

Supported by B. Braun's product portfolio

B. BRAUN – A COMPETENT PARTNER

As one of the world's major providers in the area of regional anesthesia, B. Braun supports its customers with innovative products and services.

We strive to accompany our customers through the entire patient pathway helping to optimize their processes and to provide products adapted to day-to-day clinical needs.

SYSTEM PARTNER IN REGIONAL ANESTHESIA

B. Braun, as a true system partner, helps to stay on top of evolving standards and their realization across multiple stakeholders, e.g. nurses, pharmacists and anesthetists. With access to our comprehensive product portfolio in pain therapy and through constructive dialog, our partners can benefit from B. Braun's know-how and expertise.

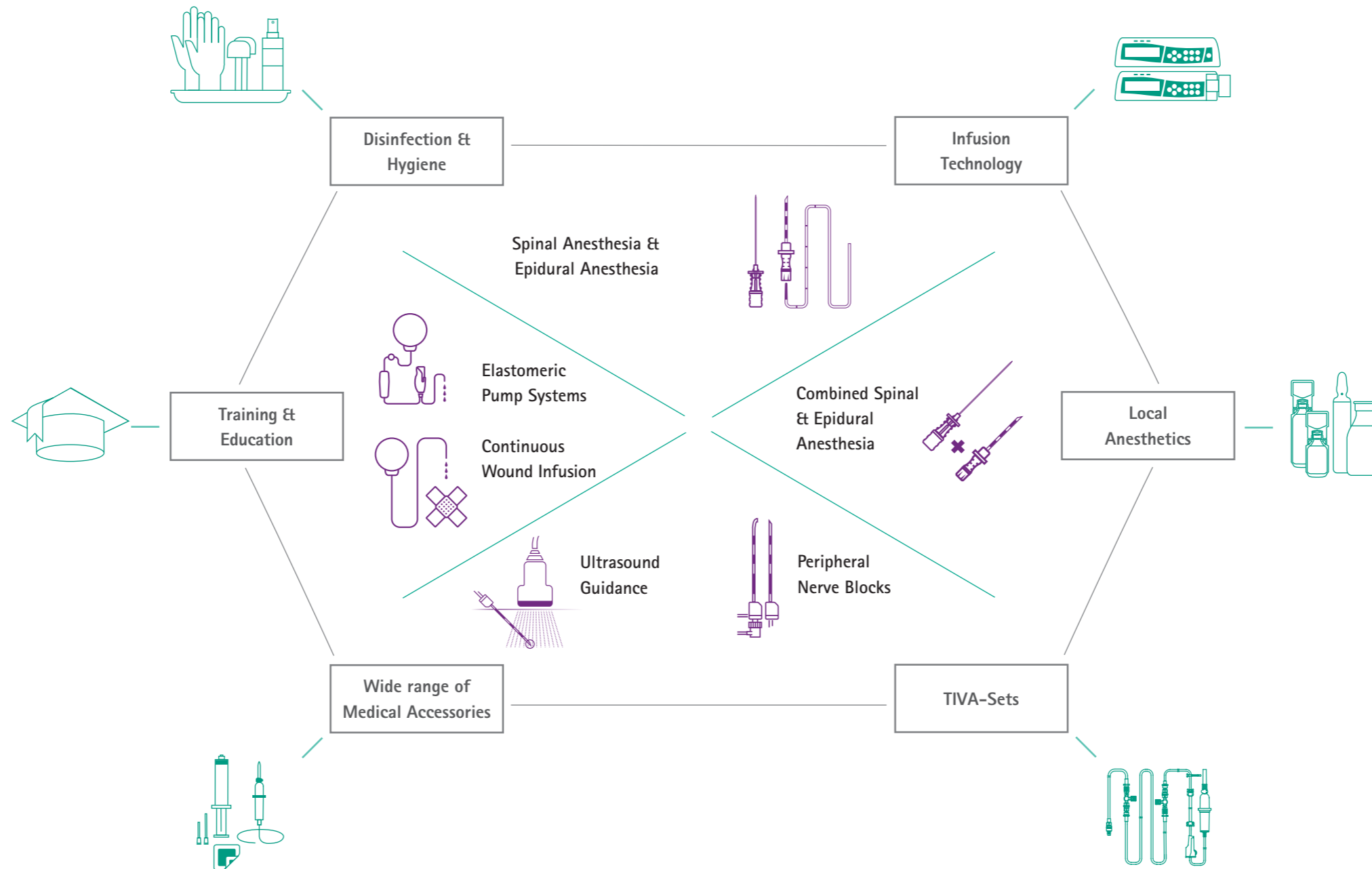

Introduction

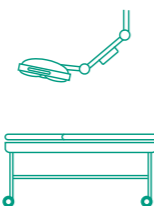

Surgery

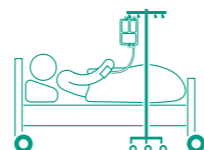

Recovery Room

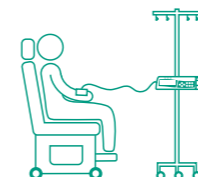

Ward

Due to the combination of different procedures a broad regional anesthesia spectrum is created, which covers all patient areas.

NRFit[®]

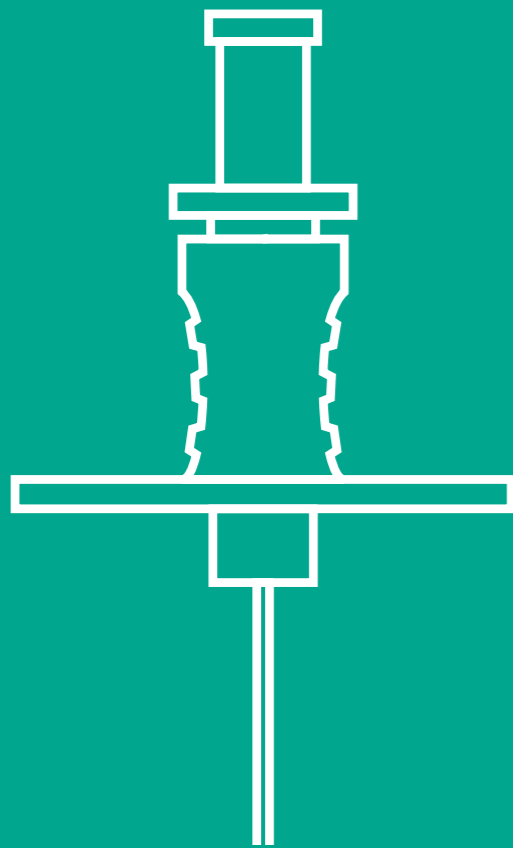

Reducing risks of misconnections in
Regional Anesthesia with NRFit[®].

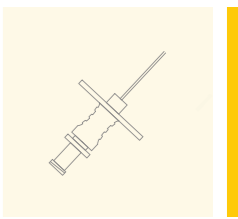

REGIONAL ANESTHESIA
WITH NRFIT[®]

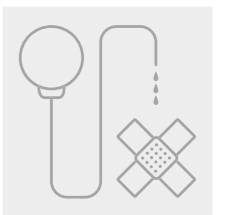
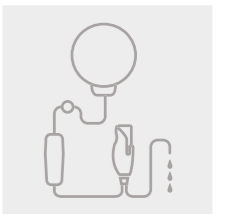
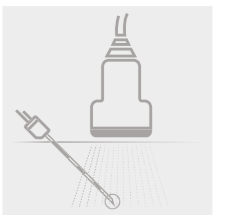
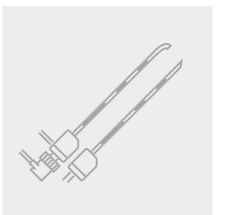
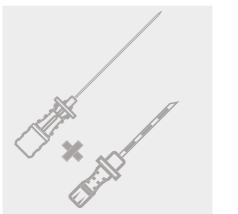
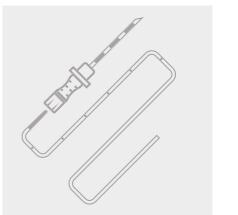
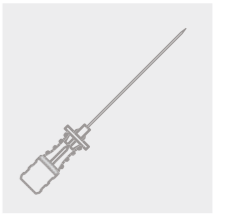

Reducing risks of misconnections in Regional Anesthesia with NRFit®

MEDICAL DEVICE CONNECTORS FOR NEURAXIAL
& REGIONAL ANESTHESIA APPLICATIONS
ARE CHANGING TO MEET INTERNATIONAL
DESIGN STANDARDS: ISO 80369-6.⁶

Regional Anesthesia products with NRFit® connector

In line with the ISO Standard (International Organization for Standardization) for neuraxial and regional anesthesia devices, B. Braun has developed a comprehensive portfolio with NRFit® connectors for the corresponding process steps.

Connecting what belongs together

» The ISO has identified several medical application areas for which specific ISO standards have been developed. These standards are part of the ISO 80369 series. Each standard will provide design and performance specifications for these connectors.¹

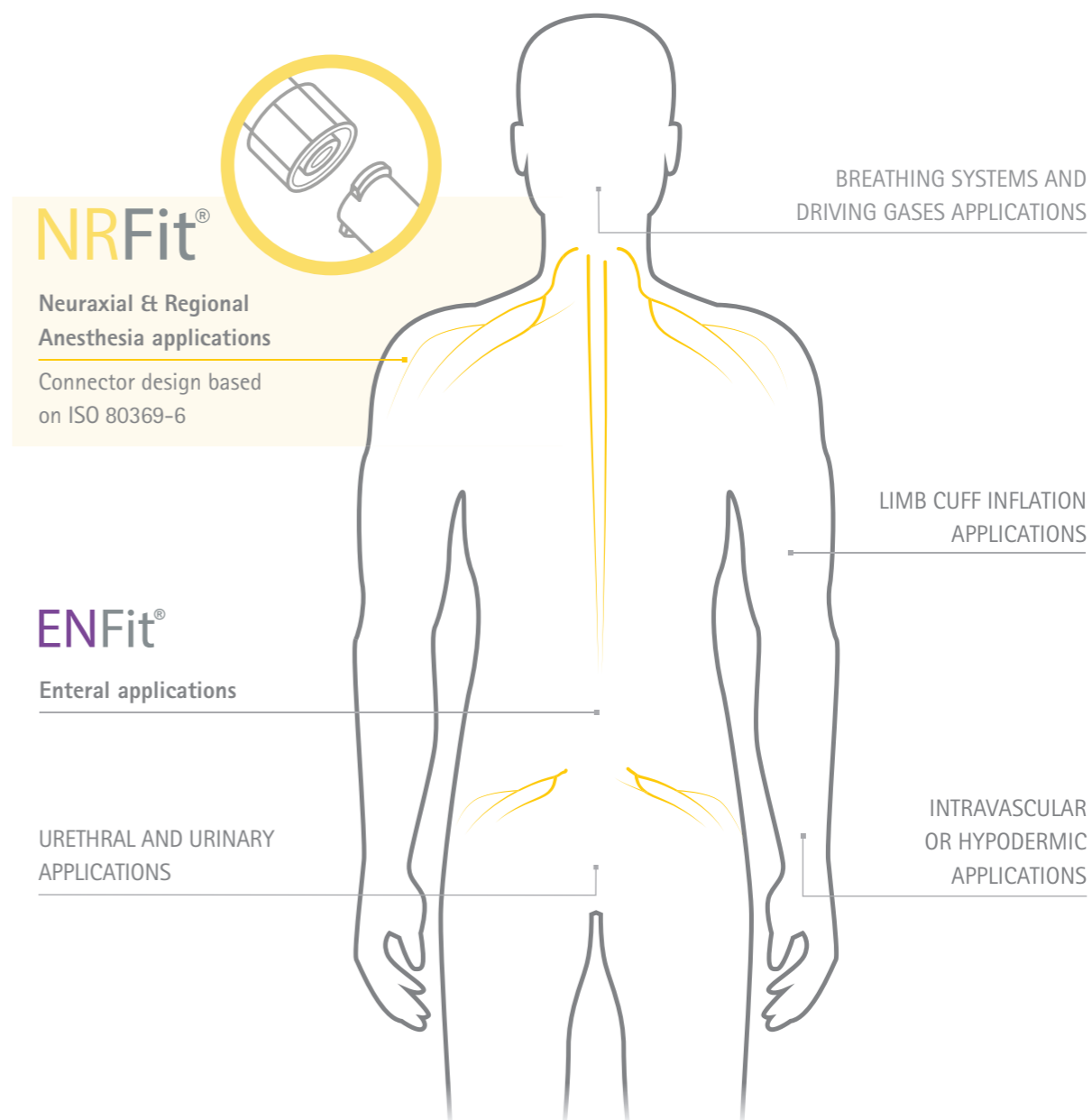

Connector changes in Regional Anesthesia

And how it impacts your working process

Observe. Listen. Understand. To find solutions that fit into everyday clinical life, B. Braun conducts a vivid dialog with customers. Learning the importance of clear structures, we identified five major steps that represent customary therapy processes. Each of these steps is mapped with aligned products that are dedicated towards improving comfort and achieving a higher level of safety for users and for patients.

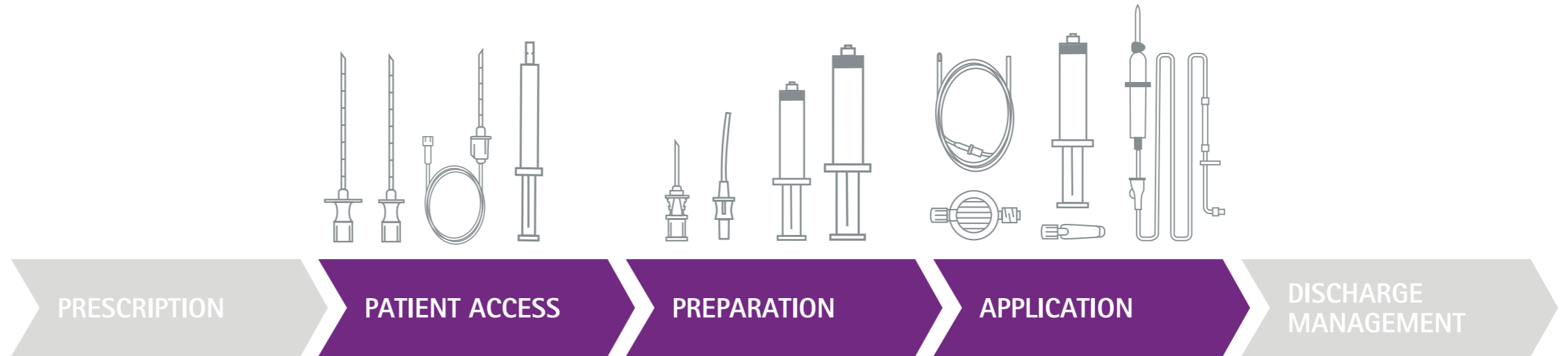

Regional Anesthesia products with NRFit® connector
 In line with the ISO Standard for neuraxial and regional anesthesia devices, B. Braun has developed a comprehensive portfolio with NRFit® connectors for the corresponding process steps:

PATIENT ACCESS: Spinal, epidural and PNB needles and LOR syringes
 PREPARATION: Filter needles, straws and syringes
 APPLICATION: Catheter, syringes, filter, catheter connector, pump disposables

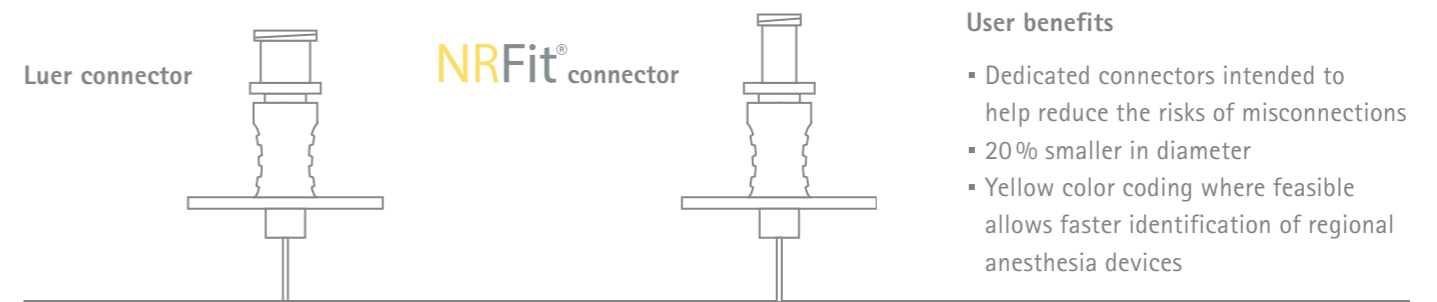

» B. Braun, as a true **System Partner**, helps to stay on top of evolving standards and their realization across multiple stakeholders, e. g. nurses, pharmacists and anesthetists. With access to our comprehensive product portfolio in Pain Therapy and through constructive dialogue, our partners benefit from B. Braun's know-how and expertise.

Regional Anesthesia accessories and complementary portfolio

Connecting what belongs together

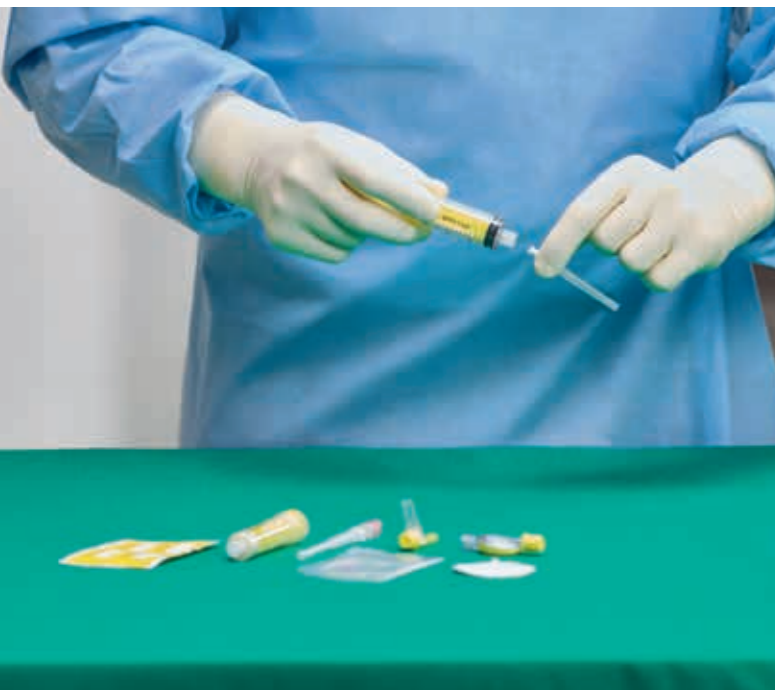

Preparation is a fundamental and irreplaceable part of health care practices. B. Braun preparation devices with NRFit® connectors are designed to reduce risks of wrong route medication errors and particulate contamination from the very beginning in neuraxial and regional anesthesia procedures.



The method of drug application depends on the chosen technique of anesthesia and on the selected post-OP pain management approach. Different options require dedicated systems. Whether the chosen method of delivery is a bolus or a continuous application, the variety of B. Braun's portfolio ensures flexibility.



The yellow product color coding of syringes and lines helps to visually differentiate between regular and NRFit® dedicated equipment.

Dedicated pump disposables with NRFit® connectors are pressure resistant and suitable for use with compatible electronic pumps.

Products with NRFit® connector

PREPARATION: DRAWING-UP DEVICES, FILTER AND CONNECTOR



Sterifix® filter needle

Equipped with a 5 µm filter, Sterifix® filter needle allows for filtering particles during the injection or the withdrawal of medication for Regional Anesthesia.



Sterifix® filter straws

Sterifix® filter straws for Regional Anesthesia with a 5 µm integrated filter allow for the withdrawal of solutions whilst filtering particles.



Perifix® filter

Perifix® filters for Regional Anesthesia are pressure resistant up to 7 bar. In combination with Perifix® PinPad, a self-adhesive fixation device, they can easily be attached to the patient's skin.



Perifix® catheter connector

Perifix® catheter connectors are available in two sizes (19G and 20/24G). A viewing window allows for catheter insertion control to ensure successful connection.

Products with NRFit® connector

APPLICATION: SYRINGES AND PUMP DISPOSABLES



NRFit® syringe caps and NRFit® stoppers

NRFit® syringe caps are a single sterile solution for storage and/or transport alongside our Omnifix® portfolio. NRFit® stoppers are there to close our NRFit® filter or Perifix® catheter connector.



Omnifix® 1-50 ml

Omnifix® 3-piece syringes are available in a broad portfolio NRFit® Slip and Lock. 3-20 ml Lock versions and 50 ml syringes with NRFit® Lock connector can be used in combination with compatible syringe pumps.



Original Perfusor® Line and Syringe 50 ml

The Original Perfusor® Line equipped with the NRFit® connector enables compatibility to NRFit® syringes for pump applications. The translucent yellow tubes help to visually differentiate from other lines.



Infusomat® Space Lines

Dedicated Infusomat® Space Lines have a piercing spike and an NRFit® patient connector. The translucent yellow tubes help to visually differentiate from other lines.

PRESCRIPTION

PATIENT ACCESS

PREPARATION







APPLICATION

DISCHARGE MANAGEMENT







Complementary portfolio with NRFit®

Product specifications

ACCESSORIES & COMPLEMENTARY PORTFOLIO

Sterifix® filter straws	Particle filter (µm)	Length (cm)	Units per box	Code no. (REF)	
	5	4.5	50	4550250N	
	5	10		4550200N	
Sterifix® filter needle	Size (G)	Particle filter (µm)	Length (cm)	Units per box	Code no. (REF)
	19	5	3.8	50	4550404N
Perifix® catheter connector	Size (G)	Units per box	Code no. (REF)		
	19	50	4513801N-01		
	20/24		4513800N-01		
Perifix® filter	Particle filter (µm)	Units per box	Code no. (REF)		
	0.2	25	4515501N-01		
Infusomat® Space Line	Length (cm)	Units per box	Code no. (REF)		
	300	100	8700132SP		
Original Perfusor®	Length (cm)	Filling volume (ml)	Units per box	Code no. (REF)	
	Original Perfusor® Line	200	--	25	8722865
	Original Perfusor® Syringe	--	50	100	8728845F-01

ACCESSORIES & COMPLEMENTARY PORTFOLIO

Omnifix®	Filling volume (ml)	Units per box	Code no. (REF)
	Slip NRFit®		
	1	100	9164001
	3		4616003
	5		4616005
	10		4616014
	20		4616021
	Lock NRFit®		
	3	100	4617003
	5		4617006
	10		4617014
	20		4617021
	50		4617508F-01
Perifix® LOR syringe	Units per box	Code no. (REF)	
	25	4637110	
	Slip NRFit®		
	25	4638110	
	Lock NRFit®		
	25	4638110	
NRFit® syringe caps NRFit® stoppers	Units per box	Code no. (REF)	
	Syringe cap with NRFit® connector		
	25	4517501N	
	Stopper with NRFit® connector		
	25	4517502N	

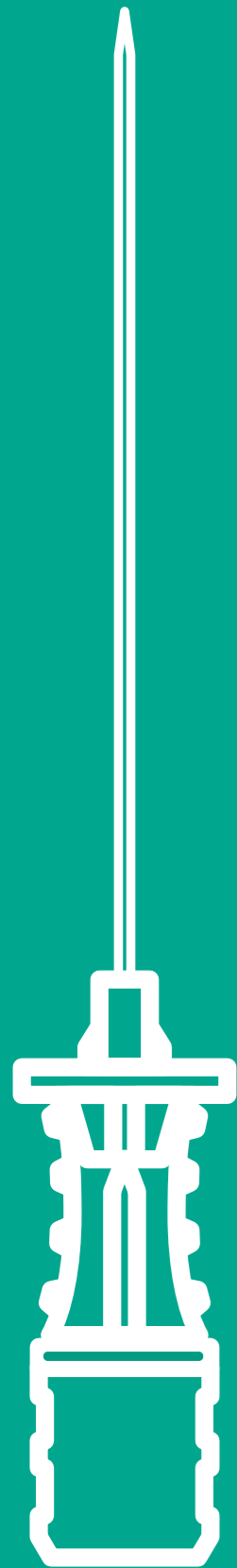

SPINAL ANESTHESIA

A comprehensive portfolio of needles in different bevel types for spinal anesthesia.

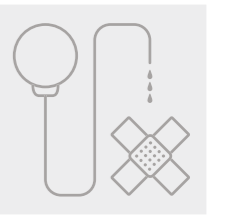
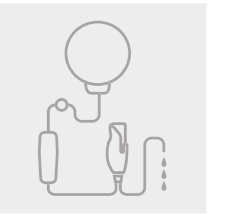
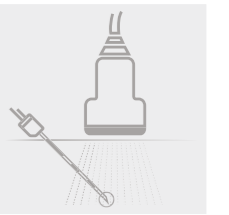
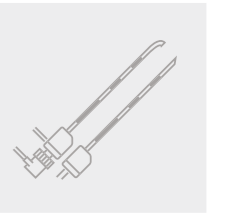
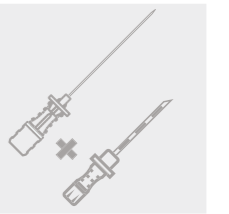
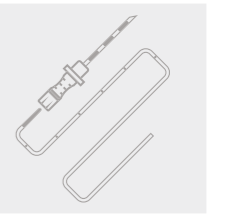
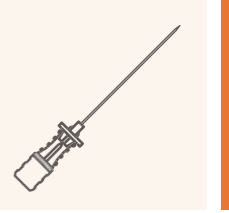
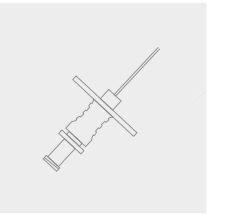

SPINAL ANESTHESIA

Products for Spinal Anesthesia

Quality and practicality



Ergonomic hub design for an individual and safe handling position, better control of the needle and easy verification of bevel eye orientation.⁷

Thanks to our years of **EXPERIENCE** in the field, B. Braun offers spinal needles with a range of bevel types.

Spinocan® and Pencan® are well accepted for their **INNOVATIVE** needle tip designs.

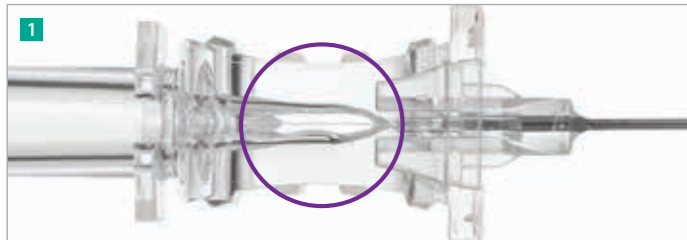

CSF-flashback identification due to the incorporated prism effect.



CSF FLASHBACK IDENTIFICATION

- Prism has a silver shine before CSF enters the hub **1**
- Prism turns transparent once CSF is in the hub **2**



Spinocan® with Quincke bevel

- Sharp bevel for low puncture force⁷
- Fitted stylet: to reduce the risk of tissue coring and potential epidural tumor development
- Prism included in the spinal needle hub, supports identification of CSF flashback



Pencan® with pencil point bevel

- Pencil point tip and opening design allows avoidance of incomplete blocks and helps reduce PDPH⁸
- Minimal intrathecal penetration depth⁷
- Identification of tissue structures due to detectable dura click^{7,9}
- Prism included in the spinal needle hub, supports identification of CSF flashback



Atraucan® with two-zone bevel

- Low puncture force as well as minimal puncture trauma¹⁰
- Reduced risk of postdural puncture headache (PDPH)¹⁰



Spinal introducer needle

- Introducer needles providing needle guidance for the spinal needle during puncture⁷
 - Introducer OHD range (as shown on left side)
 - Introducer NHD range (as shown on right side)

Portfolio overview

SPINAL NEEDLES

Spinocan®	Color code	Size (G)/ Length (inch)	ø/Length (mm)	Units per box	Code no. (REF)	Code no. (REF)	Code no. (REF)		
					OHD Luer	NHD Luer	NRFit®		
		29 x 3 1/2"	0.33 x 88*	25	4501900	4501900-13	4506090-13		
		27 x 3 1/2"	0.4 x 88		4503902	4503902-01	4503902N-01		
		26 x 3 1/2"	0.45 x 88		4502906	4502906-01	4502906N-01		
		25 x 3"	0.55 x 75		4505751	4505751-01	4505751N-01		
		25 x 3 1/2"	0.55 x 88		4505905	4505905-01	4505751N-01		
		22 x 1 1/2"	0.70 x 40		4507401	4507401-13	4507401N-01		
		22 x 3"	0.70 x 75		4507754	4507754-13	4507754N-01		
		22 x 3 1/2"	0.70 x 88		4507908	4507908-01	4507908N-01		
		20 x 3"	0.90 x 75		4509757	4509757-13	4509757N-01		
		20 x 3 1/2"	0.90 x 88		4509900	4509900-01	4509900N-01		
		19 x 1 1/2"	1.10 x 40		4501144	4501144-13	4501144N-01		
		19 x 3 1/2"	1.10 x 88		4501195	4501195-13	4501195N-01		
		18 x 3"	1.30 x 75		4501373	4501373-13	4501373N-01		
		18 x 3 1/2"	1.30 x 88		4501390	4501390-01	4501390N-01		
	Long Length								
		29 x 4 3/4"	0.33 x 120			25	-	-	4501918N-01
		27 x 4 3/4"	0.4 x 120				-	4501918-13	4502140N-01
		26 x 4 3/4"	0.45 x 120				4502140	4502140-13	4504917N-01
	25 x 4 3/4"	0.55 x 120		4504917	4504917-13		4505913N-01		
	22 x 4 3/4"	0.70 x 120		4505913	4505913-13		4506090N-01		
	22 x 6"	0.90 x 120		4506090	4506090-13		4506095N-01		

Atraucan®	Color code	Size (G)/ Length (inch)	ø/Length (mm)	Units per box	Code no. (REF)	Code no. (REF)	Code no. (REF)	
					OHD Luer	NHD Luer	NRFit®	
		26 x 3 1/2"	0.47 x 88	25	4504739	-	-	
	Atraucan® Paed							
		26 x 1"	0.47 x 25		25	4504771	-	-
	26 x 2"	0.47 x 50		4504763		-	-	

SPINAL NEEDLES

Pencan®	Color code	Size (G)/ Length (inch)	ø/Length (mm)	Units per box	Code no. (REF)	Code no. (REF)	Code no. (REF)	
					OHD Luer	NHD Luer	NRFit®	
		27 x 3 1/2"	0.4 x 88	25	4502027	4502027-01	4502027N-01	
		27 x 3 1/2"	0.4 x 88		4502051*	4502051-13*	4502051N-01*	
		25 x 3 1/2"	0.5 x 88		4502019	4502019-01	4502019N-01	
		25 x 3 1/2"	0.5 x 88		4502043*	4502043-13*	4502043N-01*	
		22 x 3 1/2"	0.7 x 88		4502035	4502035-13	4502035N-01	
	Long Length							
		27 x 4"	0.4 x 103		25	4502124*	4502124-13*	4502124N-01*
		27 x 4 3/4"	0.4 x 120			4502132*	4502132-13*	4502132N-01
		25 x 4"	0.5 x 103			4502116*	4502116-13*	4502116N-01*
		25 x 4 3/4"	0.5 x 120			-	4502120-13*	4502120N-01
	25 x 6.1"	0.5 x 156		-		-	333877N-01	
Pencan® Paed								
	27 x 2"	0.4 x 50		25	4502175	4502175-13	4502175N-01	
	25 x 1"	0.5 x 25			4502167	4502167-13	4502167N-01	
	25 x 2"	0.5 x 50			4502159	4502159-13	4502159N-01	

* with Spinal Introducer Needle (Luer)

INTRODUCER

Spinal Introducer Needles (for Spinocan® and Pencan®)	Color code	Size (G)/ Length (inch)	ø/Length (mm)	Units per box	Code no. (REF) OHD Luer	Code no. (REF) NHD Luer	Code no. (REF) NRFit®
	For spinal needles 29 G and 27 G						
		22 x 1 3/8"	0.7 x 35	25	4500059*	4500059-13*	-
For spinal needles 26 G and 25 G							
	20 x 1 3/8"	0.9 x 35		25	4505000*	4505000-13*	-

* Introducer in Luer

EPIDURAL ANESTHESIA

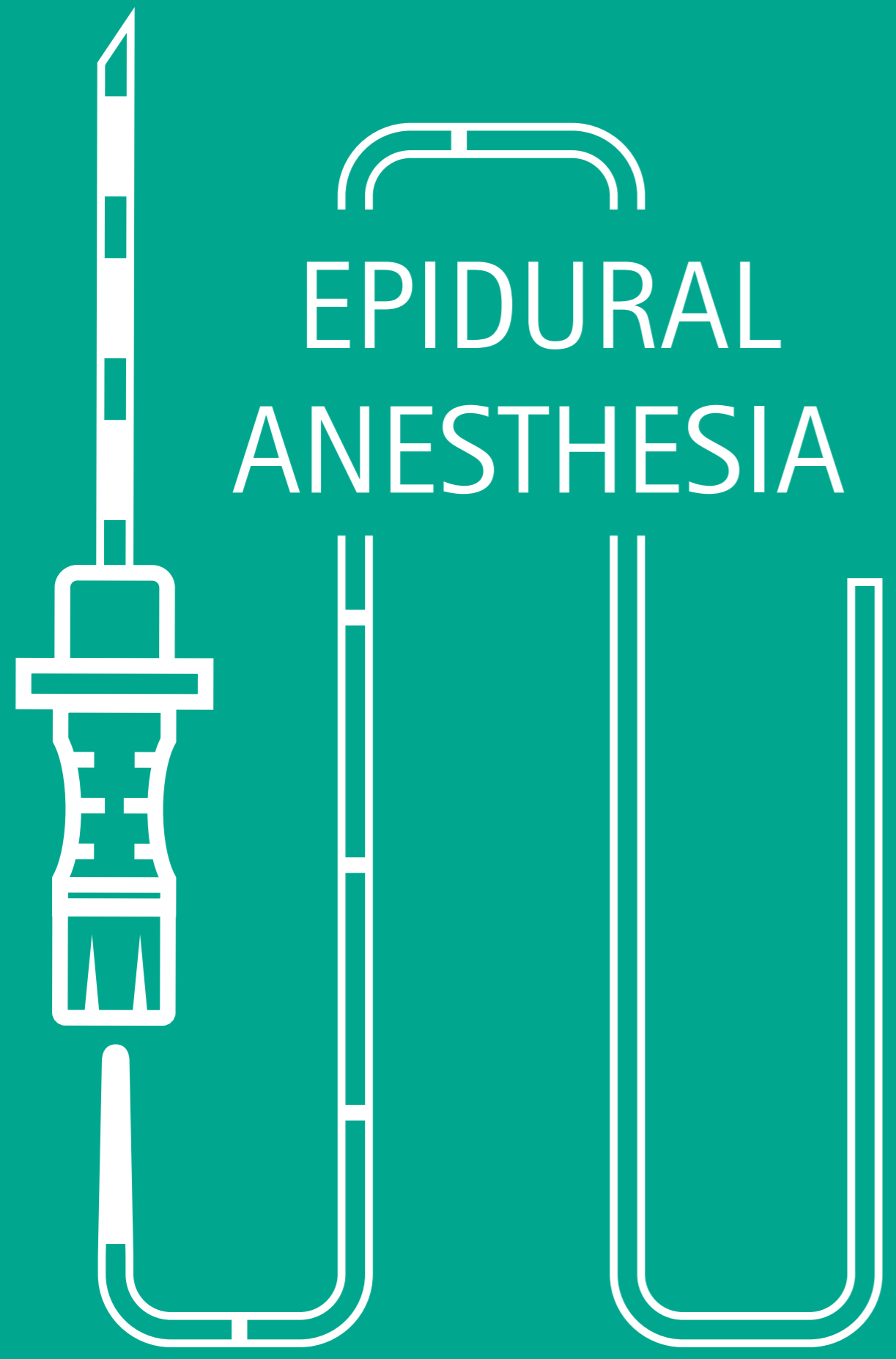

To meet individual preferences, B. Braun offers a broad range of epidural cannulas, catheters and accessories for epidural anesthesia.

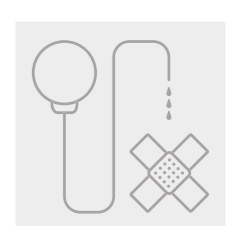
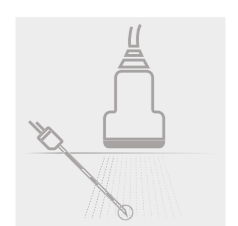
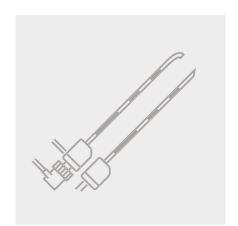
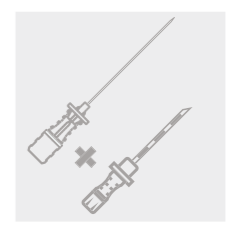
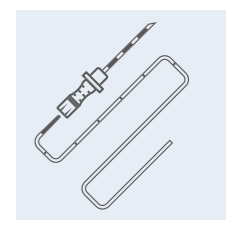
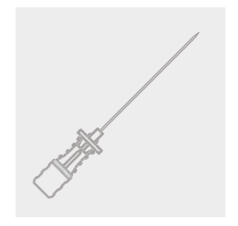
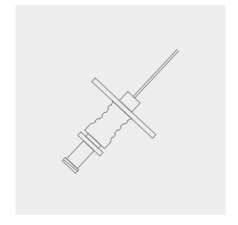

EPIDURAL ANESTHESIA

Epidural Anesthesia with NRFit®

Connecting what belongs together



Therapeutic and anesthetic decisions depend upon a number of factors, including the type and duration of the surgical intervention, patient status and selected postoperative patient management approaches.

Regional anesthesia can be divided into central and peripheral techniques. When a local anesthetic agent is used next to the spinal cord, this is referred to as neuraxial anesthesia. Neuraxial methods include spinal and epidural anesthesia.



EPIDURAL ANESTHESIA

Products with NRFit® connector

PATIENT ACCESS: EPIDURAL ANESTHESIA PRODUCTS

APPLICATION: EPIDURAL ANESTHESIA PRODUCTS



Perican®

Perican® epidural needles with Tuohy bevel are available in different sizes. Their polished inner bevel edge helps to reduce the risk of catheter shearing.



Epican® Paed Caudal

Epican® Paed Caudal needles with 45° Crawford type bevel for caudal Pediatric Anesthesia come in three different needle sizes with adjusted depth markings.



Perifix® LOR syringe

Perifix® LOR is a dedicated device for the loss of resistance technique in Epidural Anesthesia. Suitable for air and saline application. Its parabolic graduation helps to differentiate it from conventional syringes.



CSE Sets

Espocan® catheter sets for combined spinal-epidural anaesthesia (CSE). Available with or without docking system.



Perifix® catheters

Perifix® catheters for Epidural Anesthesia are available in different versions and types – Standard, Soft Tip and ONE.



Perifix® filter and Perifix® catheter connector

Filters provide an additional degree of safety and control to reduce the risk of bacterial infections. The design of the Perifix® catheter connector and its 'click and ready' mechanism ensure easy use in daily practice.

PRESCRIPTION

PATIENT ACCESS

PREPARATION

APPLICATION

DISCHARGE MANAGEMENT

Products for Epidural Anesthesia

Quality and practicality

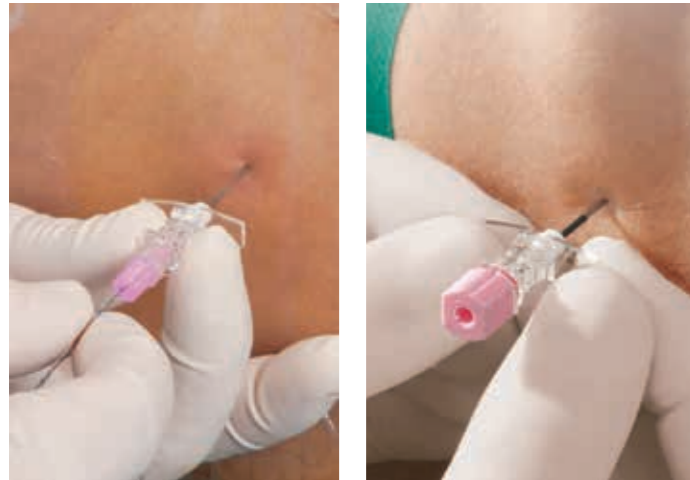

Adapting to the unique anatomical challenges of each patient, it is important to use the appropriate needle and accessories.

B. Braun focuses on

QUALITY & PRACTICALITY.



Perican® Tuohy Needles

- For both continuous and single-shot techniques
- Different needle sizes (16 G, 18 G, 20 G)
- With 1 cm graduation in length
- Polished inner bevel edge to reduce the risk of catheter shearing

USER BENEFITS:

- 1 cm marking to control the insertion depth
- High bending stiffness for good control during needle advancement
- Fitted stylet: to reduce the risk of tissue coring and potential epidermoid tumor development

Products for Epidural Anesthesia

Perifix® catheters: available with different characteristics – standard, Soft-Tip and ONE

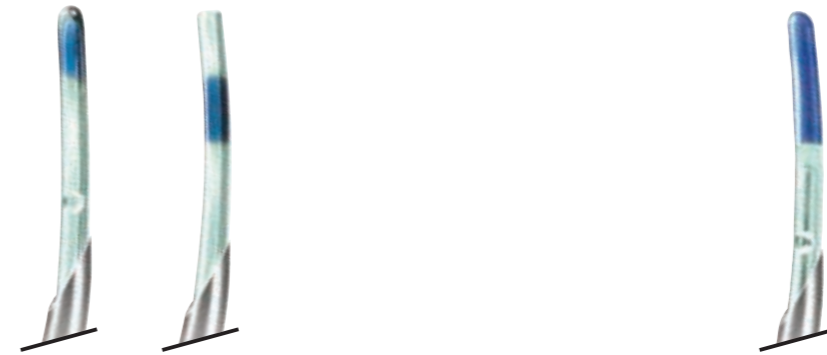

Perifix® standard catheter

- Relatively stiff catheter shaft for easy catheter insertion
- Length 1000 mm
- Standard catheter with a central opening or three micro-holes to enhance the spread
- Clear blue length markings embedded in catheter material
- Does not contain latex, DEHP or PVC
- MRI suitable

Perifix® Soft-Tip catheter

- Soft-Tip catheter with a superimposed tip
- Length 1000 mm
- Three micro-holes enhance the spread of anesthetic drug
- Clear blue length markings embedded in catheter material
- Does not contain latex, DEHP or PVC
- MRI suitable



Perifix® ONE

- Epidural catheter with a relatively stiff but flexible shaft and a soft, atraumatic tip
- Length 1000 mm
- Six micro-holes enhance the spread of anesthetic drug
- Three yellow barium sulphate stripes allowing x-ray control
- Does not contain latex, DEHP or PVC
- MRI suitable

Products for Epidural Anesthesia

Perifix® accessories



Perifix® LOR-Syringe

- Easy-gliding plunger with good gliding characteristics and safety stop
- Parabolic graduation to differentiate it from conventional syringes
- Suitable for air and saline applications
- Lock or slip connection



Perifix® filter with PinPad

- Filter fixation on patient in combination with self-adhesive PinPad
- Filter reduces the risk of bacterial infections
- Pressure resistant up to 7 bar



Perifix® catheter connector

- Available in two sizes (19 G and 20/24 G)
- Tactile and acoustic feedback upon closure
- Viewing window allows for catheter insertion control to ensure a successful connection



Perifix® catheter fixation

- Catheter fixation, consisting of fixation ring and non-woven cover foil
- Easy examination of puncture site due to exchangeable cover foils

Products for Epidural Anesthesia

Epidural anesthesia for the smallest patients



Perican® Paed epidural needles

- Tuohy bevel
- For continuous or single-shot techniques
- Three different needle sizes (18 G, 20 G, 22 G)
- 5 mm markings to control the insertion depth
- Fitted stylets: to reduce the risk of tissue coring and potential epidermoid tumor development



Epican® Paed - caudal needles

- 45° Crawford type bevel for caudal pediatric anesthesia
- Three different needle sizes (20 G, 22 G, 25 G)
- Special length (30 mm, 35 mm, 50 mm)
- 5 mm markings to control the insertion depth
- Fitted stylets: to reduce the risk of tissue coring and potential epidermoid tumor development





Perifix® ONE Paed epidural sets



Perifix® ONE Paed epidural sets in 20/24 G for newborns and infants, and 18/20 G for older children:





- Catheters with distance markings for pediatric use
- For safe catheter insertion and position control
- Catheter with markings each 1 cm in the space between 2 and 20 cm from the needle tip

Portfolio overview





EPIDURAL NEEDLES

Perican®	Color code	Size (G)/Length (inch)	ø/Length (mm)	Units per box	Code no. (REF) Luer	Code no. (REF) NRFit®	
		18 x 3¼"	1.3 x 80	25	4512383	4512383N-01	
		17 x 3¼"	1.5 x 80		4512588	-	
		16 x 3¼"	1.7 x 80		4512782	4512782N-01	
	Long Length						
		18 x 4¾"	1.3 x 120	25	4512453	4512453N-01	
		18 x 6"	1.3 x 150		4512200	4512200N-01	

Perican® Paed	Color code	Size (G)/Length (inch)	ø/Length (mm)	Units per box	Code no. (REF) Luer	Code no. (REF) NRFit®
		22 x 2"	0.73 x 50	25	4502078	4502078N-01
		20 x 2"	0.9 x 50		4502094	4502094N-01
		18 x 2"	1.3 x 50		4502302	4502302N-01

Epican® Paed Caudal	Color code	Size (G)/Length (inch)	ø/Length (mm)	Units per box	Code no. (REF) Luer	Code no. (REF) NRFit®
		25 x 1½"	0.53 x 30	25	4502400	4502400N-01
		22 x 1¾"	0.73 x 35		4502418	4502418N-01
		20 x 2"	0.9 x 50		4502426	4502426N-01

EPIDURAL CATHETERS

Perifix® catheter	Catheter ø outer/inner/Length (mm) (G)	Suitable for Perican® Size (G)	Units per box	Code no. (REF) Luer	Code no. (REF) NRFit®
	Perifix® standard catheter (with 3 lateral eyes)				
	1.05/0.60/1000 (19)	16	25	4513258	4513258N-01
	0.85/0.45/1000 (20)	18		4513150	4513150N-01
	Perifix® standard catheter (with central opening)				
	0.85/0.45/1000 (20)	18	25	4513177	4513177N-01
	Perifix® Soft Tip catheter (with 3 lateral eyes)				
	0.85/0.45/1000 (20)	18	25	4515048	4515048N-01
	Perifix® ONE catheter (with 6 lateral eyes)				
	0.85/0.45/1000 (20)	18	25	4513150C	45131501N-01

EPIDURAL ANESTHESIA SETS

Perifix® catheter fixation	Description	Units per box	Code no. (REF) Luer	Code no. (REF) NRFit®
	Perifix® catheter fixation, consisting of a fixation ring and a non-woven cover foil	25	4511200	-
	Perifix® non-woven replacement cover foil		4511201	

Perifix® Loss-of-Resistance (LOR) syringe	Description	Units per box	Code no. (REF) Luer
	Perifix® LOR Syringe, Luer-Slip	25	4637100
	Perifix® LOR Syringe, Luer-Lock		4638107

Perifix® Loss-of-Resistance (LOR) syringe NRFit®	Description	Units per box	Code no. (REF) NRFit®
	Perifix® LOR Syringe, Slip NRFit®	25	4637110
	Perifix® LOR Syringe, Lock NRFit®		4638110

Perifix® catheter connector	Size (G)	Units per box	Code no. (REF) Luer	Code no. (REF) NRFit®
	19	25	4513801	4513801N-01
	20/24		4513800	4513800N-01

Perifix® filter	Particle filter (µm)	Units per box	Code no. (REF) Luer	Code no. (REF) NRFit®
	0.2	25	4515501	4515501N-01

Perifix® PinPad	Description	Units per box	Code no. (REF)
	Perifix® PinPad Filter Fixation	25	4515510

Portfolio overview

SETS FOR EPIDURAL ANESTHESIA (LUER)

Perican® Tuohy epidural needles		Perican® Tuohy epidural needle		Perifix® ONE epidural catheter, 6 lateral eyes			Perifix® epidural catheter, 3 lateral eyes			central opening	3 lateral eyes	Perifix® Loss-of-Resistance (LOR) syringe, Luer-Slip								
<input checked="" type="checkbox"/>	20G ø 0.9 mm/Length 50 mm		50/80 mm		24 G		20 G		19 G		20 G		20 G		20 G					
<input checked="" type="checkbox"/>	18G ø 1.3 mm/Length 80 mm		120 mm																	
<input checked="" type="checkbox"/>	18G ø 1.3 mm/Length 50 mm (Paed Set)																			
<input type="checkbox"/>	16G ø 1.7 mm/Length 80 mm																			
Complete Sets	Type	Perican®	Perifix® ONE	Perifix® standard			Perifix® Soft-Tip	Perifix® LOR									Sales unit/Pcs.	Code no. (REF) Luer		
Perifix® standard catheter																				
	Perifix® 420	<input checked="" type="checkbox"/>					<input checked="" type="checkbox"/>										10	4514203		
	Perifix® 421	<input checked="" type="checkbox"/>					<input checked="" type="checkbox"/>											10	4514211	
	Perifix® 430	<input type="checkbox"/>						<input checked="" type="checkbox"/>											10	4514300
Perifix® Soft-Tip catheter																				
	Perifix® 901	<input checked="" type="checkbox"/>										<input checked="" type="checkbox"/>							10	4510305
Perifix® ONE catheter																				
	Perifix® ONE431	<input type="checkbox"/>					<input checked="" type="checkbox"/>												10	4514319C
Filter Sets																				
Perifix® standard catheter																				
	Perifix® 400	<input checked="" type="checkbox"/>																	20	4514009
	Perifix® 401	<input checked="" type="checkbox"/>																	20	4514017
	Perifix® 402	<input type="checkbox"/>																	20	4514025
	Perifix® 451	<input checked="" type="checkbox"/>																	20	4514513
Perifix® Soft Tip catheter																				
	Perifix® 700	<input checked="" type="checkbox"/>																	20	4510216
	Perifix® 701	<input checked="" type="checkbox"/>																	20	4510097
	Perifix® 730	<input type="checkbox"/>																	20	4517309
	Perifix® 750	<input checked="" type="checkbox"/>																	20	4517504
Perifix® ONE catheter																				
	Perifix® ONE400	<input checked="" type="checkbox"/>																	20	4514009C
	Perifix® ONE401	<input checked="" type="checkbox"/>																	20	4514017C
	Perifix® ONE402	<input type="checkbox"/>																	20	4514025C
	Perifix® ONE418	<input checked="" type="checkbox"/>																	20	4514183C
	Perifix® ONE451	<input checked="" type="checkbox"/>																	20	4514513C
Pediatric Filter Sets																				
Perifix® ONE Paed																				
	Perifix® ONE Paed 18	<input checked="" type="checkbox"/>																	10	4512006C
	Perifix® ONE Paed 20	<input checked="" type="checkbox"/>																	10	4512014C
Mini Sets																				
Perifix® Standard catheter																				
	Perifix® 100	<input checked="" type="checkbox"/>																	20	4511000
	Perifix® 300	<input checked="" type="checkbox"/>																	20	4513002
	Perifix® 301	<input checked="" type="checkbox"/>																	20	4513010
	Perifix® 302	<input type="checkbox"/>																	20	4513029
	Perifix® 310	<input type="checkbox"/>																	20	4513100

Omnifix® three part syringe, 3 ml, Luer-Lock	Omnifix® three part syringes, 3 ml, 20 ml, Luer-Lock, 3 hypodermic needles*	Omnifix® three part syringes, 3 ml, 10 ml, 20 ml, Luer-Lock, 3 hypodermic needles*	Perifix® epidural filter 0.2 µm pressure resistant up to 7 bar	Perifix® PinPad filter fixation	Perifix® catheter connector	* Sterican® needles	Sales unit/Pcs.	Code no. (REF) Luer
<input checked="" type="checkbox"/>	<input checked="" type="checkbox"/>	<input checked="" type="checkbox"/>	<input checked="" type="checkbox"/>	<input checked="" type="checkbox"/>	<input checked="" type="checkbox"/>	25G Length 16 mm, ø 0.5 mm		4514203
<input checked="" type="checkbox"/>	<input checked="" type="checkbox"/>	<input checked="" type="checkbox"/>	<input checked="" type="checkbox"/>	<input checked="" type="checkbox"/>	<input checked="" type="checkbox"/>	21G Length 40 mm, ø 0.8 mm	10	4514211
<input checked="" type="checkbox"/>	<input checked="" type="checkbox"/>	<input checked="" type="checkbox"/>	<input checked="" type="checkbox"/>	<input checked="" type="checkbox"/>	<input checked="" type="checkbox"/>	18G Length 40 mm, ø 1.2 mm		4514300
<input checked="" type="checkbox"/>	<input checked="" type="checkbox"/>	<input checked="" type="checkbox"/>	<input checked="" type="checkbox"/>	<input checked="" type="checkbox"/>	<input checked="" type="checkbox"/>		10	4510305
<input checked="" type="checkbox"/>	<input checked="" type="checkbox"/>	<input checked="" type="checkbox"/>	<input checked="" type="checkbox"/>	<input checked="" type="checkbox"/>	<input checked="" type="checkbox"/>		10	4514319C
<input checked="" type="checkbox"/>	<input checked="" type="checkbox"/>	<input checked="" type="checkbox"/>	<input checked="" type="checkbox"/>	<input checked="" type="checkbox"/>	<input checked="" type="checkbox"/>		20	4514009
<input checked="" type="checkbox"/>	<input checked="" type="checkbox"/>	<input checked="" type="checkbox"/>	<input checked="" type="checkbox"/>	<input checked="" type="checkbox"/>	<input checked="" type="checkbox"/>		20	4514017
<input checked="" type="checkbox"/>	<input checked="" type="checkbox"/>	<input checked="" type="checkbox"/>	<input checked="" type="checkbox"/>	<input checked="" type="checkbox"/>	<input checked="" type="checkbox"/>		20	4514025
<input checked="" type="checkbox"/>	<input checked="" type="checkbox"/>	<input checked="" type="checkbox"/>	<input checked="" type="checkbox"/>	<input checked="" type="checkbox"/>	<input checked="" type="checkbox"/>		20	4514513
<input checked="" type="checkbox"/>	<input checked="" type="checkbox"/>	<input checked="" type="checkbox"/>	<input checked="" type="checkbox"/>	<input checked="" type="checkbox"/>	<input checked="" type="checkbox"/>		20	4510216
<input checked="" type="checkbox"/>	<input checked="" type="checkbox"/>	<input checked="" type="checkbox"/>	<input checked="" type="checkbox"/>	<input checked="" type="checkbox"/>	<input checked="" type="checkbox"/>		20	4510097
<input checked="" type="checkbox"/>	<input checked="" type="checkbox"/>	<input checked="" type="checkbox"/>	<input checked="" type="checkbox"/>	<input checked="" type="checkbox"/>	<input checked="" type="checkbox"/>		20	4517309
<input checked="" type="checkbox"/>	<input checked="" type="checkbox"/>	<input checked="" type="checkbox"/>	<input checked="" type="checkbox"/>	<input checked="" type="checkbox"/>	<input checked="" type="checkbox"/>		20	4517504
<input checked="" type="checkbox"/>	<input checked="" type="checkbox"/>	<input checked="" type="checkbox"/>	<input checked="" type="checkbox"/>	<input checked="" type="checkbox"/>	<input checked="" type="checkbox"/>		20	4514009C
<input checked="" type="checkbox"/>	<input checked="" type="checkbox"/>	<input checked="" type="checkbox"/>	<input checked="" type="checkbox"/>	<input checked="" type="checkbox"/>	<input checked="" type="checkbox"/>		20	4514017C
<input checked="" type="checkbox"/>	<input checked="" type="checkbox"/>	<input checked="" type="checkbox"/>	<input checked="" type="checkbox"/>	<input checked="" type="checkbox"/>	<input checked="" type="checkbox"/>		20	4514025C
<input checked="" type="checkbox"/>	<input checked="" type="checkbox"/>	<input checked="" type="checkbox"/>	<input checked="" type="checkbox"/>	<input checked="" type="checkbox"/>	<input checked="" type="checkbox"/>		20	4514183C
<input checked="" type="checkbox"/>	<input checked="" type="checkbox"/>	<input checked="" type="checkbox"/>	<input checked="" type="checkbox"/>	<input checked="" type="checkbox"/>	<input checked="" type="checkbox"/>		20	4514513C
<input checked="" type="checkbox"/>	<input checked="" type="checkbox"/>	<input checked="" type="checkbox"/>	<input checked="" type="checkbox"/>	<input checked="" type="checkbox"/>	<input checked="" type="checkbox"/>		10	4512006C
<input checked="" type="checkbox"/>	<input checked="" type="checkbox"/>	<input checked="" type="checkbox"/>	<input checked="" type="checkbox"/>	<input checked="" type="checkbox"/>	<input checked="" type="checkbox"/>		10	4512014C
<input checked="" type="checkbox"/>	<input checked="" type="checkbox"/>	<input checked="" type="checkbox"/>	<input checked="" type="checkbox"/>	<input checked="" type="checkbox"/>	<input checked="" type="checkbox"/>		20	4511000
<input checked="" type="checkbox"/>	<input checked="" type="checkbox"/>	<input checked="" type="checkbox"/>	<input checked="" type="checkbox"/>	<input checked="" type="checkbox"/>	<input checked="" type="checkbox"/>		20	4513002
<input checked="" type="checkbox"/>	<input checked="" type="checkbox"/>	<input checked="" type="checkbox"/>	<input checked="" type="checkbox"/>	<input checked="" type="checkbox"/>	<input checked="" type="checkbox"/>		20	4513010
<input checked="" type="checkbox"/>	<input checked="" type="checkbox"/>	<input checked="" type="checkbox"/>	<input checked="" type="checkbox"/>	<input checked="" type="checkbox"/>	<input checked="" type="checkbox"/>		20	4513029
<input checked="" type="checkbox"/>	<input checked="" type="checkbox"/>	<input checked="" type="checkbox"/>	<input checked="" type="checkbox"/>	<input checked="" type="checkbox"/>	<input checked="" type="checkbox"/>		20	4513100

Portfolio overview

SETS FOR EPIDURAL ANESTHESIA (NRFit®)

Set versions	Perican® Tuohy needle		Perifix® ONE epidural catheter, 6 lateral eyes			Perifix® epidural catheter, 3 lateral eyes		Perifix® Soft-Tip epidural catheter, 3 lateral eyes	Perifix® Loss of Resistance syringe
	50 mm	80 mm	24 G	20 G	19 G	20 G	19 G	20 G	
Complete sets									
Perifix® Soft-Tip 901		■							■
Perifix® ONE 421		■		■					■
Filter sets									
Perifix® 400		■				■			
Perifix® 401		■				■			■
Perifix® 402		□					■		■
Perifix® Soft Tip 701		■						■	■
Perifix® Soft Tip 730		□						■	■
Perifix® ONE 401		■		■					■
Perifix® ONE 402		□			■				■
Pediatric sets									
Perifix® ONE Paed 18		■			■				■
Perifix® ONE Paed 20	■			■					■
Mini set									
Perifix® 300		■				■			■

Omnifix® and Sterifix® with NRFit®	Omnifix® and Sterifix® with NRFit®	Perifix® Filter with NRFit®	Perifix® catheter connector with NRFit®	Perifix® PinPad	Omnifix® and hypodermic needles with Luer	Units per box	Code no. (REF) NRFit®
■	■	■	■	■	■		4510305N-01
■	■	■	■	■	■		45142111N-01
■	■	■	■	■	■		4514009N-01
■	■	■	■	■	■		4514017N-01
■	■	■	■	■	■	10	4514025N-01
■	■	■	■	■	■		4510097N-01
■	■	■	■	■	■		4517309N-01
■	■	■	■	■	■		45140171N-01
■	■	■	■	■	■		45140251N-01
■	■	■	■	■	■	10	45120061N-01
■	■	■	■	■	■		45120141N-01
■	■	■	■	■	■	10	4513002N-01

* Sterican® needles
 25 G, 16 mm, ø 0.5 mm
 21 G, 40 mm, ø 0.8 mm
 18 G, 40 mm, ø 1.2 mm

Caution: Hypodermic needles (for skin infiltration) stay Luer

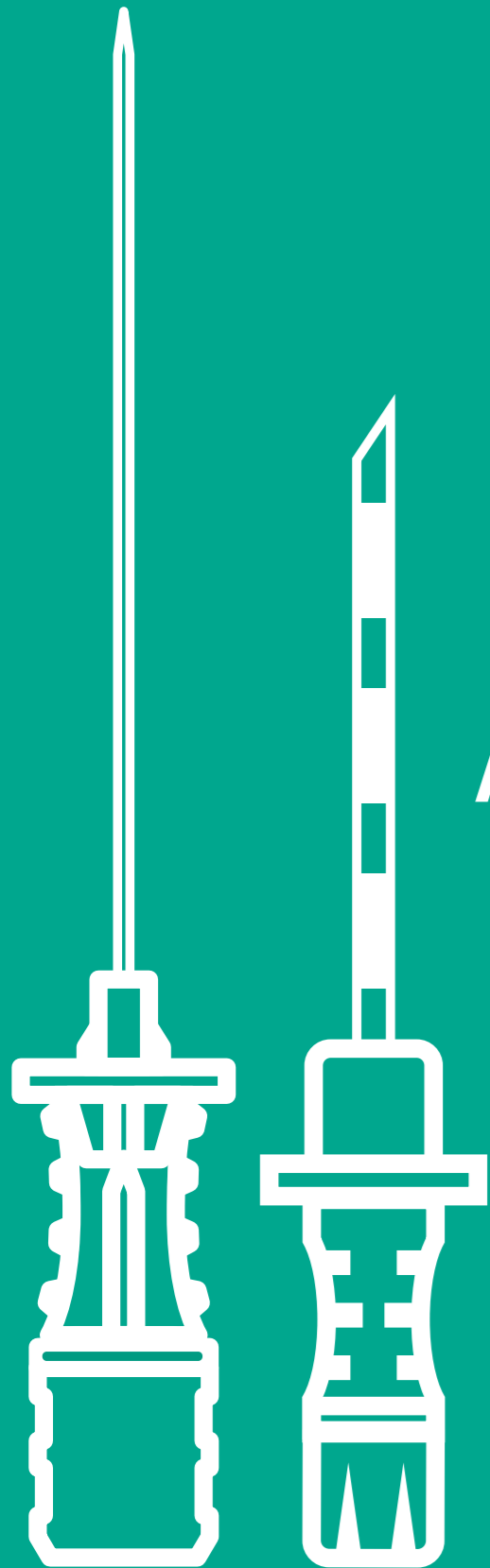

COMBINED SPINAL AND EPIDURAL ANESTHESIA

Combining the benefits of both techniques – sets for combined spinal and epidural anesthesia (CSE).

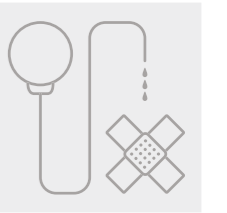
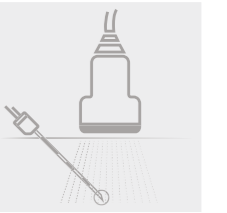
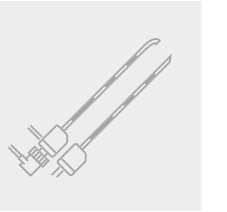
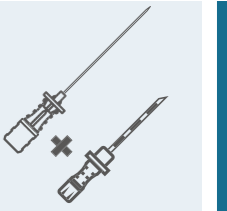
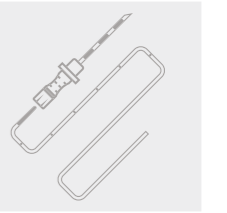
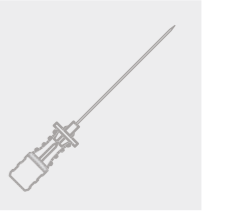
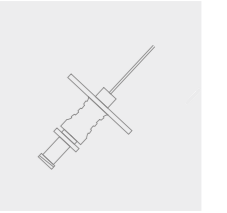

COMBINED SPINAL AND
EPIDURAL ANESTHESIA

Products for Combined Spinal and Epidural Anesthesia

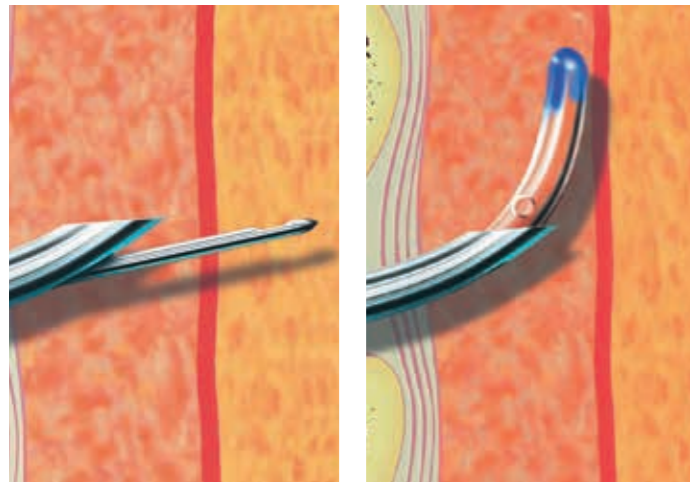

Combined Spinal-Epidural Anesthesia (CSE):

THE BENEFITS

of spinal and epidural anesthesia in the Espocan®-Sets

Special Tuohy Needle with a back-eye in the curved tip and a Spinal Needle with a plastic centering sleeve

- Back-eye in tuohy needle for insertion of spinal needle
- Docking system to fixate the spinal needle
- Sleeved spinal needle for smooth exit through the back-eye

The ideal overlap of the spinal needle is by



Markings on the Spinal Needle 1

The markings on the spinal needle show, when the tip leaves the back-eye.

USER BENEFITS 2

- The docking system allows rotation of the spinal needle even in the fixed position. Avoids the difficult and uncomfortable finger grip to steady fix the spinal needle in position
- The docking system ensures fixation of the spinal needle inside the tuohy needle after successful dura puncture and injection of the local anesthetic

Portfolio overview

SETS FOR COMBINED SPINAL AND EPIDURAL ANESTHESIA

Espocan® and Perifix® standard	Size (G)/ Length (inch)	ø / Length (mm)	Units per box	Code no. (REF) Luer	Code no. (REF) NRFit®
	With Quincke-Bevel: Spinocan®				
	27 x 5"	0.42 x 125.5*	10	4556674	4556674N-01
	Pencil-Point Cannula: Pencan®				
	27 x 5"	0.42 x 127.5*	10	4556666	4556666N-01
All sets contain					
<ul style="list-style-type: none"> ▪ Perifix® Standard catheter, 3 lateral eyes ▪ Perican® epidural cannula ø 1.3 mm, 18 G x 90 mm ▪ Perifix® LOR-syringe, Luer-Slip ▪ Perifix® epidural flat filter 0.2 µm ▪ Perifix® PinPad ▪ Perifix® catheter connector 					

Espocan® and Perifix® Standard with docking system	Size (G)/ Length (inch)	ø / Length (mm)	Units per box	Code no. (REF) Luer	Code no. (REF) NRFit®
	With Quincke-Bevel: Spinocan®				
	27 x 5 3/8"	0.42 x 136.5*	10	-	4556747N-01
	Pencil-Point Cannula: Pencan®				
	27 x 5 3/8"	0.42 x 138.5*	10	4556763	4556763N-01
All sets contain					
<ul style="list-style-type: none"> ▪ Perifix® Soft-Tip catheter, 3 lateral eyes ▪ Docking system ▪ Perican® epidural cannula ø 1.3 mm, 18 G x 90 mm ▪ Perifix® LOR-syringe, Luer-Slip ▪ Perifix® epidural flat filter 0.2 µm ▪ Perifix® PinPad ▪ Perifix® catheter connector 					

* for CSE needle length in NRFit®, please consult our NRFit® brochure

PERIPHERAL NERVE BLOCKS

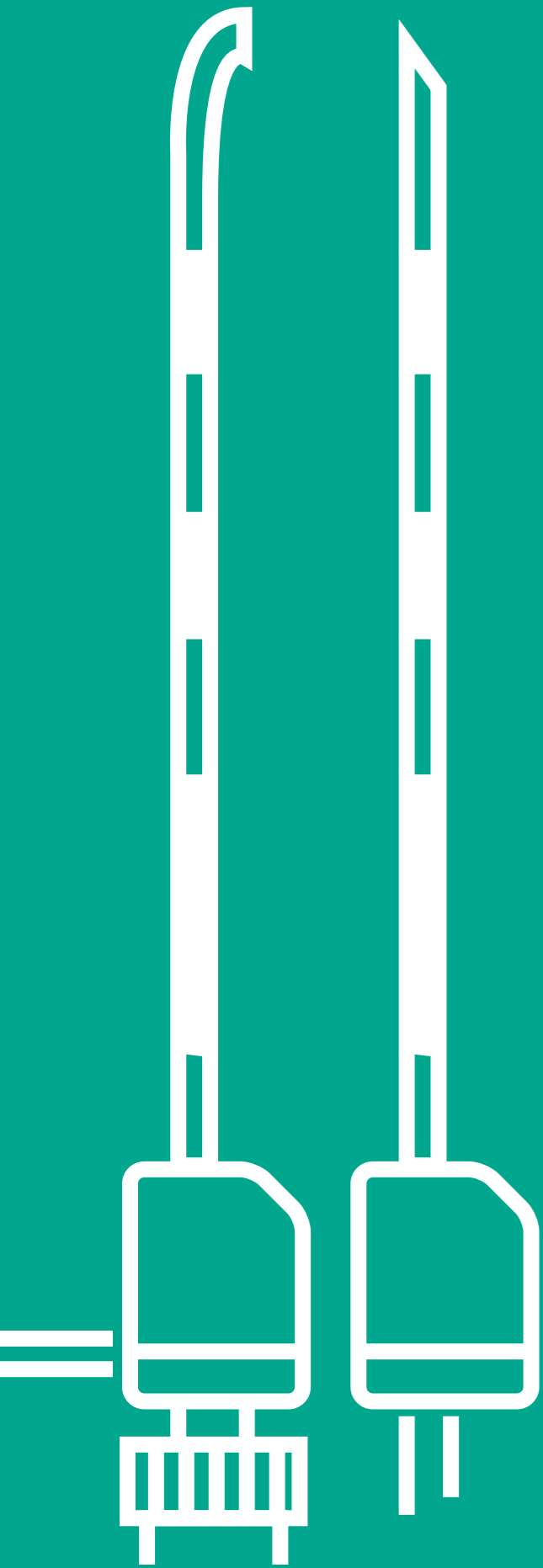

Whatever option you prefer - wide ranged product portfolio for stimulated and ultrasound guided peripheral nerve blocks.

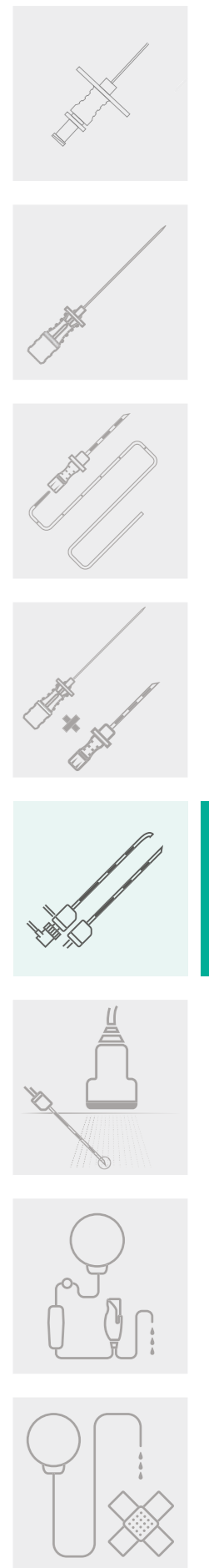

PERIPHERAL NERVE BLOCKS

Peripheral nerve blocks with NRFit®

Connecting what belongs together



Peripheral and plexus nerve blocks are one of the segments of regional anesthesia, where a local anesthetic agent is used next to a nerve to provide sensory and motor blockades.

Peripheral nerve blocks (PNB) can be employed for anesthesia and for postoperative analgesia in order to support early patient mobilization and rehabilitation. PNBs are also used in combination with other forms of anesthesia and where volatile anesthetics are contraindicated.

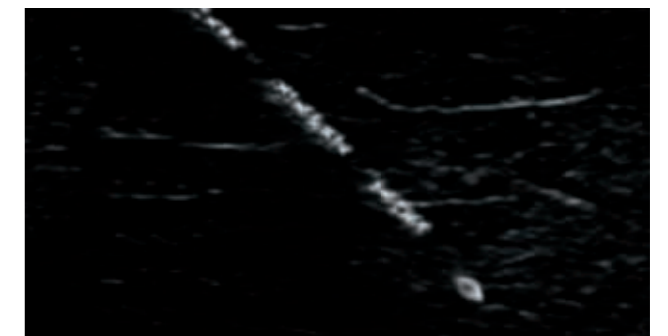
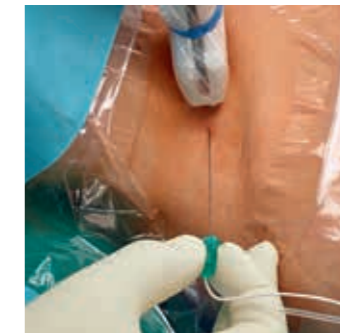

Products with NRFit® connector

PATIENT ACCESS: SINGLE SHOT PNB PRODUCTS



Stimuplex® Ultra 360° needles

Stimuplex® Ultra 360° is designed to perform an ultrasound guided peripheral nerve block and nerve stimulation. Due to high visibility of the X-pattern, the needle is easy to visualize under ultrasound with few artefacts.



Ultraplex® 360 needles

Ultraplex® 360 is a non-stimulating ultrasound needle, equipped with improved product properties to perform ultrasound guided peripheral nerve blocks, when nerve stimulation is not indicated (e.g. transversus abdominalplane block).



Stimuplex® A

Stimuplex® A is a single shot unipolar needle, providing the basic nerve stimulation-supported anesthesia for short-term interventions or additional single nerve blocks in continuous techniques.

PATIENT ACCESS: CONTINUOUS PNB PRODUCTS



Contiplex® S Ultra 360° needles

Contiplex® S Ultra 360° is a continuous technique needle with a 20° facet bevel, designed to perform ultrasound guided peripheral nerve blocks in combination with nerve stimulation.



Contiplex® Tuohy Ultra 360° needles

Contiplex® Tuohy Ultra 360° is a continuous technique needle with Tuohy bevel, designed to perform ultrasound guided peripheral nerve blocks in combination with nerve stimulation.



Contiplex® C

Contiplex® C is a patented catheter placement system with the innovative catheter-over-needle design. It is designed to help overcome the limitations associated with peripheral catheters, such as complexity of catheter placement, leakage and catheter displacement.

PRESCRIPTION

PATIENT ACCESS

PREPARATION

APPLICATION

DISCHARGE MANAGEMENT

Peripheral nerve block portfolio

Quality and functionality without compromise

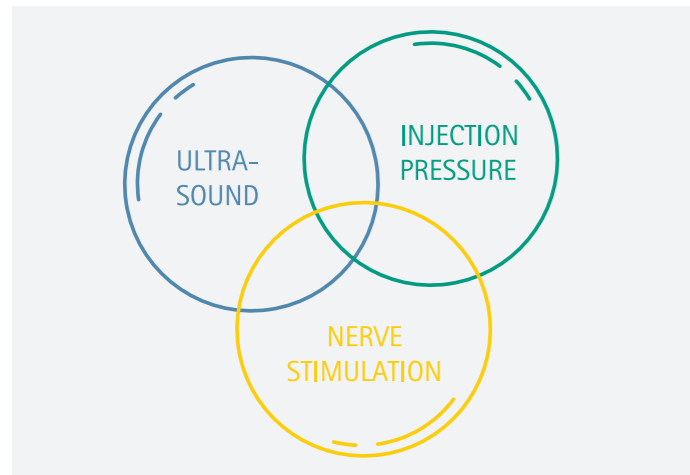

When performing a peripheral nerve block, there is no such thing as being too safe. Peripheral nerve blocks can be performed using different techniques and approaches. Electrical nerve stimulation, ultrasound guidance and injection pressure monitoring can be used alone or in combination.

B. Braun's broad peripheral nerve block portfolio offers solutions for ultrasound-only, dual guidance monitoring, and stimulation procedures.



ULTRASOUND

B. Braun offers a large product range of echogenic needles and catheters. Ultraline 360 is the latest generation of Ultrasound needles that combines enhanced ultrasound visibility with smooth gliding properties and a good puncture quality.¹¹



NERVE STIMULATION

For the electrical nerve stimulation B. Braun provides a wide range of stimulating needle and catheter systems that address the users' needs. The well established nerve stimulator Stimuplex® HNS 12 completes the offer.



INJECTION PRESSURE MONITORING

The disposable BSmart™ pressure monitor device objectively indicates the opening injection pressure in real time and allows for a more informed decision on how to proceed with an injection regardless of who performs the block. Using this technique can prevent injection into poorly compliant tissue (e.g. nerve fascicles).

Ultraline 360

Visibility without compromise – the next generations of echogenic nerve block needles



Circular (360°)
X-pattern-design

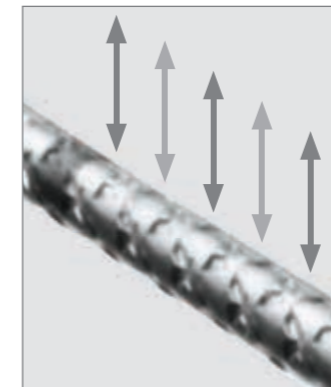

Reflection of the
Ultrasound waves

B. BRAUN ULTRASOUND NEEDLES – ULTRALINE 360:

The Ultraline 360 is B. Braun's latest generation of echogenic nerve block needles, featuring B. Braun's new echogenic 360° X-pattern. The 'X' is a unique shape, which when combined with a clear coating, is intended to reflect more ultrasound waves back to the probe than previous designs.¹¹

The X-pattern is applied as a segmented safety-code (long-short-short-tip) and facilitates the needle tip identification. The Ultraline 360 portfolio combines increased ultrasound visibility with excellent tactile feedback and puncture characteristics.

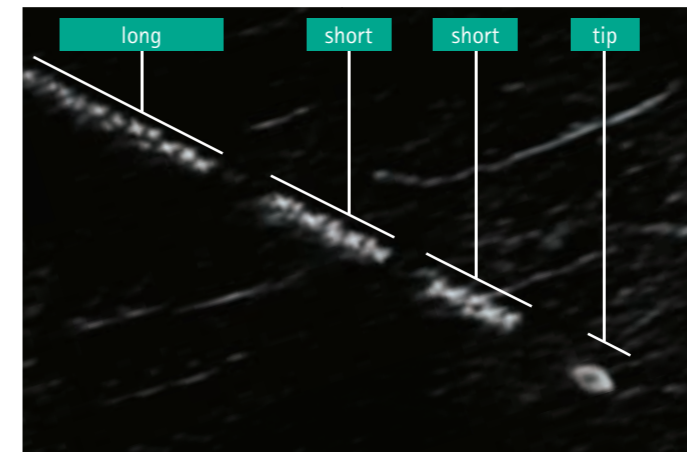

NAVIGATION

For an easy identification of the needle tip, the X-pattern is strategically applied on the first 20 mm of the needle shaft to create the segmented code "long-short-short-tip". This enables distinction between the needle tip and the upper needle shaft.¹¹

USER BENEFITS

- **Navigation:** Safety code for identification of the needle and needle tip position
- **Visibility:** 360° X-pattern and clear coating result in better Ultrasound visualization and tip identification compared to previous designs
- **Tactile Feedback:** designed for consistent puncture – same 30° back-cut bevel as previous Stimuplex® Ultra and Ultraplex® needles

Products for peripheral nerve blocks

Single shot needles



Stimuplex® and Ultraplex® single shot needles offer precision and ergonomics and are designed for high success rates.

USER BENEFITS

- Excellent puncture and gliding characteristics (Stimuplex® D)
- Broad portfolio of needle lengths from 35 to 150 mm and G 25 to G 20
- Ergonomic needle hub design for enhanced tactile feedback

Cannula	Bevel		Insulation		Echogenic properties	Stimulating capabilities
	15°	30°	Full Tip	PinPoint		
Stimuplex® A	✓	✓	✓		✓	✓
Stimuplex® Ultra 360°	✓	✓	✓		✓	✓
Ultraplex® 360°	✓				✓	



Products for peripheral nerve blocks

Sets for continuous peripheral nerve Blocks



Contiplex® Continuous Nerve Block Sets
Continuous peripheral nerve blocks provide pain relief during and after surgical procedures, for improved patient recovery.¹²

USER BENEFITS

- Wide range of catheter sets
- Harmonized set components
- Good ultrasound visibility of Perifix® ONE catheter

Set	Bevel			Insulation	Echogenic properties	Catheter	
	15°	20°	30°	Tuohy		Standard	ONE
Braunula technique							
Contiplex® D	✓		✓			✓	
Catheter through the needle technique							
Contiplex® S Ultra 360		✓			✓		✓
Contiplex® Tuohy Ultra 360				✓	✓		✓
Catheter over the needle							
Contiplex® C	✓		✓		✓		✓

Products for peripheral nerve blocks

Nerve stimulation with the Stimuplex® HNS 12



1 Stimuplex® HNS 12 with SENSE



2 Stimuplex® Pen for cutaneous nerve mapping

B. Braun Nerve stimulator – Stimuplex® HNS 12 with SENSE

What is SENSE?

In practice, marginal needle movements often lead to losing the muscle twitch. The SENSE technology (Sequential electrical Nerve Stimulation) is a sequence of two fixed impulse durations of 0.1 ms along with a third longer impulse duration.¹³ Most traditional nerve stimulators emit two very short pulses every second. That's because short pulses improve accuracy or specificity when closer to the nerve. The downside is that sensitivity, or the availability to elicit visual feedback at a distance from the nerve, is lost. SENSE technology increases both sensitivity and specificity by adding a third, longer pulse. This results in eliciting a motor response even when the needle is far from or not aimed directly at the nerve and requires less adjustment to the amperage control while remaining the visual feedback.

USER BENEFITS

- Stimulation with SENSE-technology designed for more efficient nerve stimulation¹³
- Menus designed for easy control of sound and other settings
- Acoustic signals inform the user of any relevant deviations

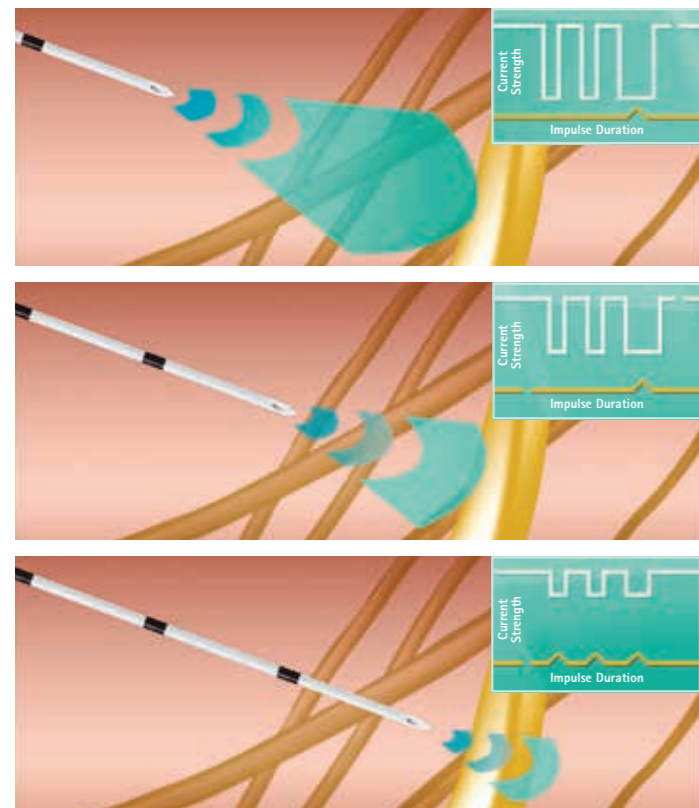

As the needle is advanced, SENSE generates two short and one long pulse. From the alternating sequence of three impulses, the third longer impulse stimulates the nerve already at a distance. One muscle twitch is visible and indicates that the needle is directed to the nerve.

The stimulation needle is further advanced towards the nerve while SENSE maintains the motor response. Current strength adjustments lead to definite reductions of the third impulse.

At the threshold level of approximately 0.5 mA three muscle twitches are visible as all three impulses stimulate the nerve.

Products for peripheral nerve blocks

Injection pressure monitoring with BSmart™



Injection pressure monitoring

Accidental injection of local anesthetic into fascicles of peripheral nerves can result in permanent nerve injury.¹ Research has shown that high opening injection pressure (> 15 psi) indicates needle-nerve-contact or intrafascicular injection.^{14,15,16,17,18}

USER BENEFITS

- Objectively measures and displays injection pressure
- Color coding visualizes the pressure information
- Allows consistent monitoring of resistance to injection regardless of who performs the actual injection¹⁹
- Allows for standardized and objective documentation of injection pressure information during nerve block procedures



The pressure information is conveniently displayed by the colour-coded pressure ranges on the BSmart™ piston.

BSmart™ Injection Pressure Monitor

The BSmart™ Injection Pressure Monitor is an easy-to-use inline injection pressure monitoring device providing clinicians with objective pressure information. This happens through a coloured piston, which climbs into the gauge depending on the pressure. BSmart™ Injection Pressure Monitor does not interfere with the tactile feedback of the syringe which has been traditionally used to assess the resistance of injection during nerve block procedures.

Portfolio overview

SINGLE-SHOT BLOCK NEEDLES

Stimuplex® A	Needle ø (G) and Length (inch)	Needle ø and Length (mm)	Units per box	Code no. (REF) Luer	Code no. (REF) NRFit®
	Needles with 30° bevel				
	24 G x 1"	0.55 x 25 mm	25	4894251	-
	22 G x 1"	0.70 x 25 mm		-	4894539NR
	22 G x 1 1/8"	0.70 x 35 mm		4894367	4894367NR
	22 G x 2"	0.70 x 50 mm		4894502	4894502NR
	21 G x 2"	0.80 x 50 mm		-	4894375NR
	21 G x 4"	0.80 x 100 mm		4894260	4894260NR
20 G x 6"	0.90 x 150 mm	4894278		-	

Stimuplex® Ultra 360°	Needle ø (G) and Length (inch)	Needle ø and Length (mm)	Units per box	Code no. (REF) Luer	Code no. (REF) NRFit®
	Insulated echogenic needles with 30° Bevel				
	22 G x 1 3/8"	0.70 x 35 mm	25	4892503-01	4892503NR-01
	22 G x 2"	0.70 x 50 mm		4892505-01	4892505NR-01
	22 G x 3 1/8"	0.70 x 80 mm		4892508-01	4892508NR-01
	20 G x 4"	0.90 x 100 mm		4892510-01	4892510NR-01
20 G x 6"	0.90 x 150 mm	4892515-01		4892515NR-01	

*SUFFIXES
Article code suffix -01 = CE Region: Covering all CE countries; Article code suffix -03 = Asia; Article code suffix -04 = South America; Article code suffix -20 = CIS

Ultraplex® 360	Needle ø (G) and Length (inch)	Needle ø and Length (mm)	Units per box	Code no. (REF) Luer	Code no. (REF) NRFit®
	Non-Insulated Echogenic Needles with 30° Bevel				
	22 G x 1 3/8"	0.70 x 35 mm	25	4892603-01	4892603NR-01
	22 G x 2"	0.70 x 50 mm		4892605-01	4892605NR-01
	22 G x 3 1/8"	0.70 x 80 mm		4892608-01	4892608NR-01
	20 G x 4"	0.90 x 100 mm		4892610-01	4892610NR-01
20 G x 6"	0.90 x 150 mm	4892615-01		4892615NR-01	

*SUFFIXES
Article code suffix -01 = CE Region: Covering all CE countries; Article code suffix -20 = CIS

ACCESSORIES

BSmart™	Description	Units per box	Code no. (REF)
	BSmart™ Injection Pressure Monitor	25	4894000-01





Nerve stimulation	Description	Units per box	Code no. (REF)
	Stimuplex® HNS 12 Nerve Stimulator for Stimuplex®, Ultraplex® and Contiplex® needles	1	4892098

Nerve stimulator accessories and spare parts	Units per box	Code no. (REF)
Stimuplex® Pen for cutaneous nerve mapping	1	4892099
Electrode cable for Stimuplex® HNS 11/12		4892070
Battery cover for Stimuplex® HNS 12		4892094
Carrying Case for Stimuplex® HNS 12		4892095
Test resistor for Stimuplex® HNS 12		4892096
Knob for special handling		4892283

*Stimuplex® HNS Compact is not available in all countries

Portfolio overview

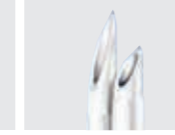
SETS FOR CONTINUOUS NERVE BLOCKS

							
	25 G	18 G	18 G	18 G			
Set specifications	Bevel (°)		Needle		Perifix standard		
	with NRFit®	with NRFit®	Size (G)	Size Ø (mm)	Length (mm)	3 lateral openings (closed tip) (mm)	central opening (open tip) (mm)
			with NRFit®	with NRFit®			
Contiplex® C Sets							
Contiplex® C		15	25	0.53	190	-	-
Contiplex® C		30	25	0.53	190	-	-
Contiplex® D Sets							
Contiplex® D		15	18	1.3	110	-	1000
Contiplex® D		15	20	1.1	33	-	400
Contiplex® D		15	20	1.1	55	-	400
Contiplex® D		15	18	1.3	55	-	400
Contiplex® D		30	18	1.3	55	-	400
Contiplex® S Ultra 360® Sets							
Contiplex® S Ultra 360		20	18	1.3	50	-	-
Contiplex® S Ultra 360		20	18	1.3	100	-	-
Contiplex® S Ultra 360		20	18	1.3	150	-	-
Contiplex® Tuohy Ultra 360® Sets							
Contiplex® Tuohy Ultra 360		-	18	1.3	40	-	-
Contiplex® Tuohy Ultra 360		-	18	1.3	50	-	-
Contiplex® Tuohy Ultra 360		-	18	1.3	100	-	-
Contiplex® Tuohy Ultra 360		-	18	1.3	150	-	-

							
Contiplex ONE catheter (6 lateral openings, closed tip, open tip for Contiplex® C)	Perifix catheter connector 19G or 20/24G	Perifix PinPad filter fixation	Perifix filter 0.2 µm, Pressure resistant up to 7 bar	Omnifix syringe 5 ml			
Contiplex ONE (mm)	Perifix catheter connector	Perifix PinPad	Perifix Filter with NRFit®	Omnifix with NRFit®	Units per box	Code no. (REF) Luer	Code no. (REF) NRFit®
187	■	■	■	-	5	4898115	-
187	■	■	■	-		4898130	4898130NR
-	■	■	■	■	10	4898311	-
-	■	■	■	■		4898323	-
-	■	■	■	■		4898325	-
-	■	■	■	■		4898305	-
-	■	■	■	■		4898335	-
400	■	■	■	■	10	4898650-01	4898650NR-27
1000	■	■	■	■		4898610-01	4898610NR-27
500	■	■	■	■		4898615-01	4898615NR-27
400	■	■	■	■	10	4898704-01	4898704NR-27
400	■	■	■	■		4898705-01	4898705NR-01
1000	■	■	■	■		4898710-01	4898710NR-01
1000	■	■	■	■		4898715-01	4898715NR-01

*SUFFIXES

Contiplex® Tuohy Ultra 360: Article code suffix -01 = CE Region: covering all CE countries; Article code suffix -27 = RoW

Contiplex® S Ultra 360: Article code suffix -01 = CE Region: covering all CE countries; Article code suffix -27 = RoW

ULTRASOUND GUIDANCE

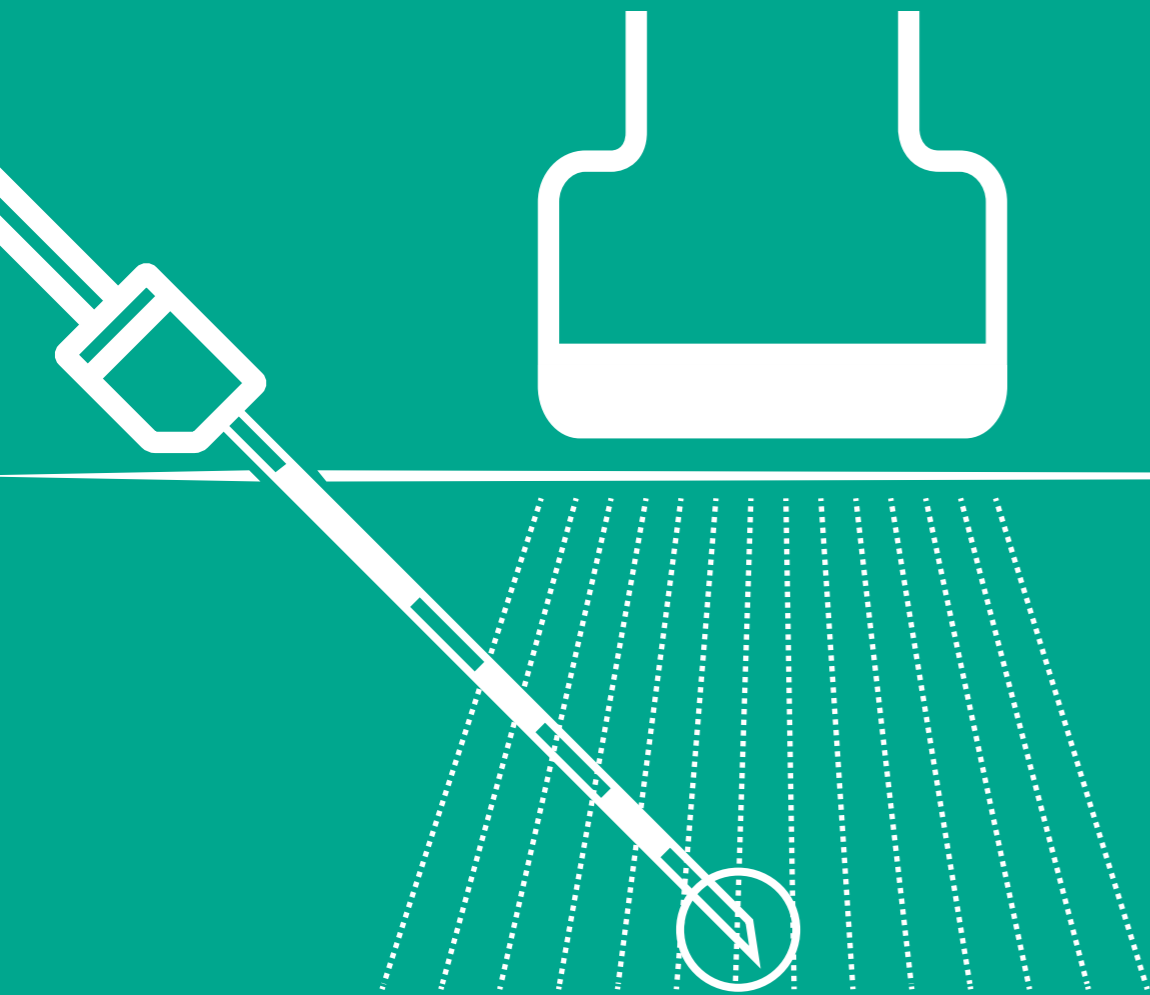

Reimagine Regional Anesthesia
with B. Braun's innovative portfolio
for ultrasound guided therapies.

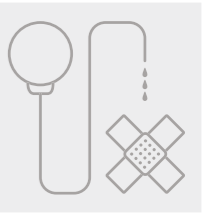
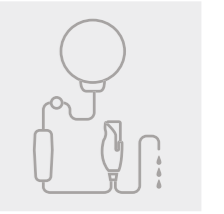
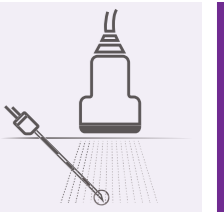
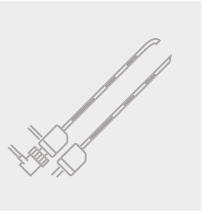
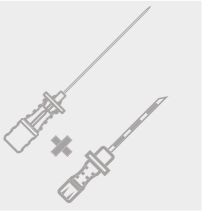
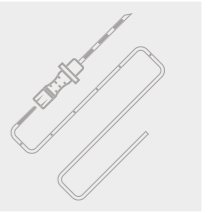
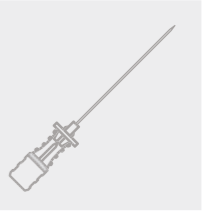
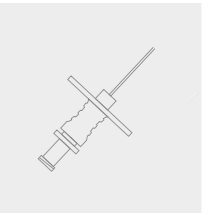

Xperius® ultrasound system

Responsive | Advanced | Simple



Xperius® is a new ultrasound system jointly developed by B. Braun and Philips which has been specifically designed to support the current and future needs in regional anesthesia and vascular access at the point of care.

RESPONSIVE

The system offers a high degree of mobility and flexibility combined with an ergonomic design to improve daily practice. A fully articulating arm allows easy adjustments of the ultrasound monitor position and the angle of the screen for ergonomic use and better line of sight. Besides the cart based system, a dedicated ultra portable tablet device allows quick bedside scanning or interventions in your facility, on-the-go and at satellite locations.

ADVANCED

Xperius® provides high quality imaging of nerves and tissue structures for confident diagnoses and precise needle guidance. The predetermined settings (presets) are designed so you can spend less time adjusting controls and more time focusing on your patients.

SIMPLE

Xperius® – Allows you to quickly and comfortably conduct exams. Xperius® comes with intuitive touch and gesture controls that you already know from your smart devices – to keep your focus on your work and not on the controls. Its simple interface supports daily routines and provides specific presets for procedures in regional anesthesia and vascular access.

Designed around you to fit seamlessly into the anesthesiologists' care area

- ✓ Advanced ergonomics
- ✓ Convenient accessory bins
- ✓ High mobility & portability
- ✓ Designed by Philips & B. Braun

High performance technology delivers exceptional image quality

- ✓ High definition imaging
- ✓ Enhanced needle visualization
- ✓ New generation of probes

Intuitive and easy to use

- ✓ Improved workflow
- ✓ Intuitive user experience
- ✓ Touch screen & gesture control
- ✓ Dedicated regional anesthesia & vascular access presets

Intuitive interface & advanced technology

- Multiple presets - 4 specific ones for regional anesthesia / vascular access
- Intuitive touchscreen
- Start scanning in a few seconds
- Built-in Wi-Fi for DICOM data transfer
- Needle Vis Technology

Ready-to-go for bedside scanning

- Long lasting battery up to 3 h of scanning
- Lightweight and easy to handle

Articulating arm

- Flexible rotation in every direction (270°)
- Height-adjustable

Core ultrasound technology

- Transducer with USB connector

Convenient storage

- Everything needed for procedures is within reach

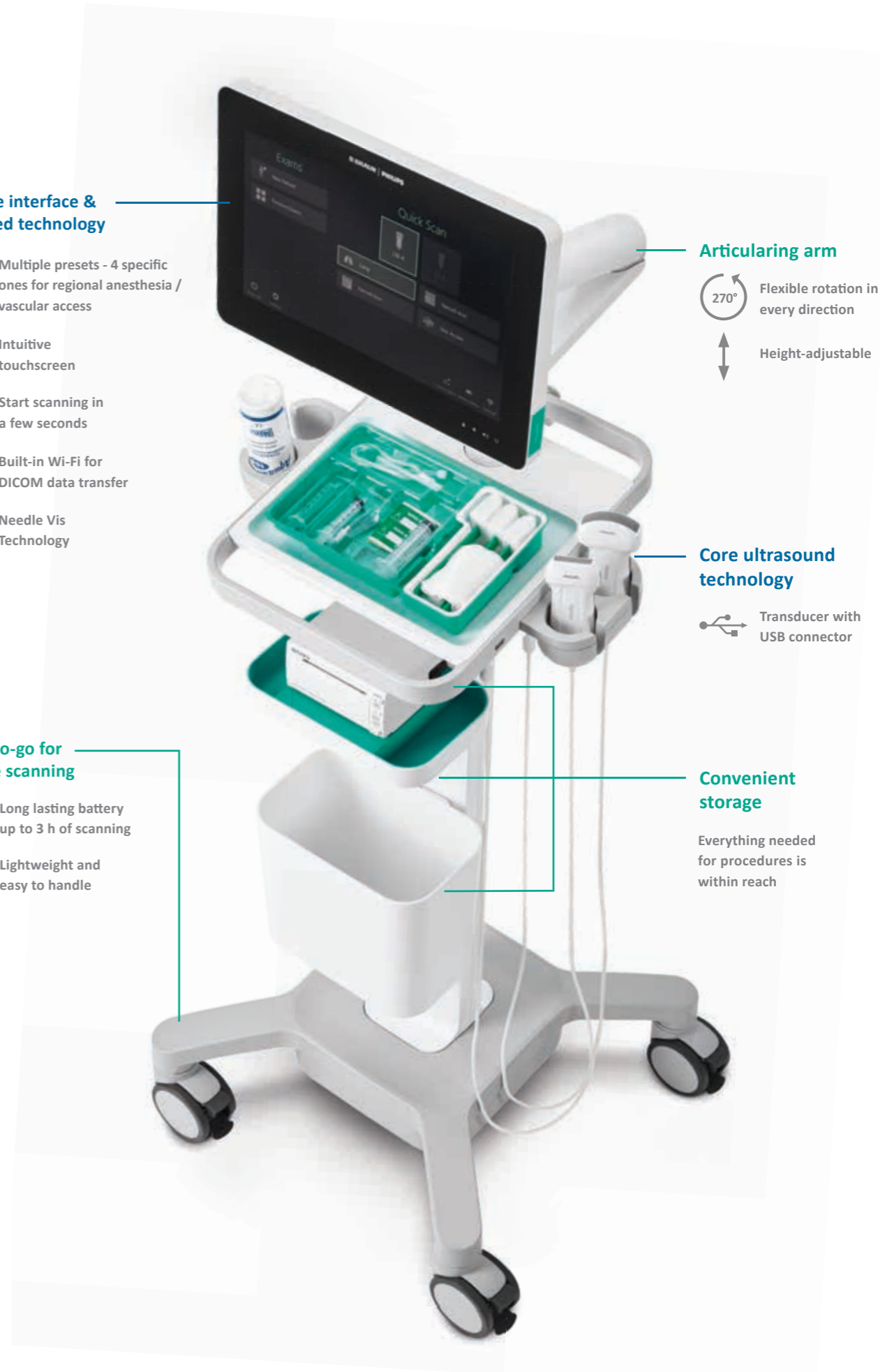

Onvision® Needle Tip Tracking

Accurate | Predictable | Empowering



Onvision® is an Ultrasound based Needle-Tip tracking technology for peripheral nerve blocks which works exclusively with the Xperius® Ultrasound system and the dedicated Stimuplex® Onvision® needle. In real-time, Onvision® accurately indicates where the needle tip is inside the body, both in and out of plane. It helps users align the needle with the probe in an intuitive and easy to use manner – to improve pain relief and the avoidance of unintended nerve puncture or collateral damage to surrounding tissue or vessel.

Onvision® is an ultrasound based technology for reliable needle guidance

The dedicated Stimuplex® Onvision® needle is embedded with a tip sensor, which allows accurate detection of the tip location and displays this information in real time on the live ultrasound image. Needle-Tip tracking can be used in 2D mode with the nerve 0-4 cm and the nerve 4-6 cm preset on the L12-4 transducer and nerve 6+ cm presets on the C5-2 transducer depending on the anatomical depth of the nerve.

ACCURATE

Know where you are in real-time^{20,21}

- ✓ Tip visualization in both superficial and deeper blocks
- ✓ Ultrasound based detection and accuracy
- ✓ Can reduce complications during PNB placement
- ✓ Designed to prevent unintended overshooting

PREDICTABLE

Helping make first-time-right the new standard^{20,21}

- ✓ Confidently perform local anesthetics injection
- ✓ Reduction in overall procedure time
- ✓ Fits in to current workflow (no workflow disruption)

EMPOWERING

More anesthesiologists can carry out regional anesthesia²²

- ✓ Intuitive user experience
- ✓ Easy to adopt
- ✓ Can increase proficiency level



Stimuplex® Onvision®

Stimuplex® Onvision® is a 30° bevel single shot cannula with tip sensor. Insulated peripheral nerve block needle for use with Philips Onvision® system. Can be used in conjunction with electrical nerve stimulation and/or ultrasound respectively for precise detection of definite nerve areas.

Needle tip navigation to the point

With Onvision®, users experience a real time guidance which empowers them to quickly adopt and integrate PNB into their daily practice. Onvision® enables more physicians to be proficient in performing PNBs.²³

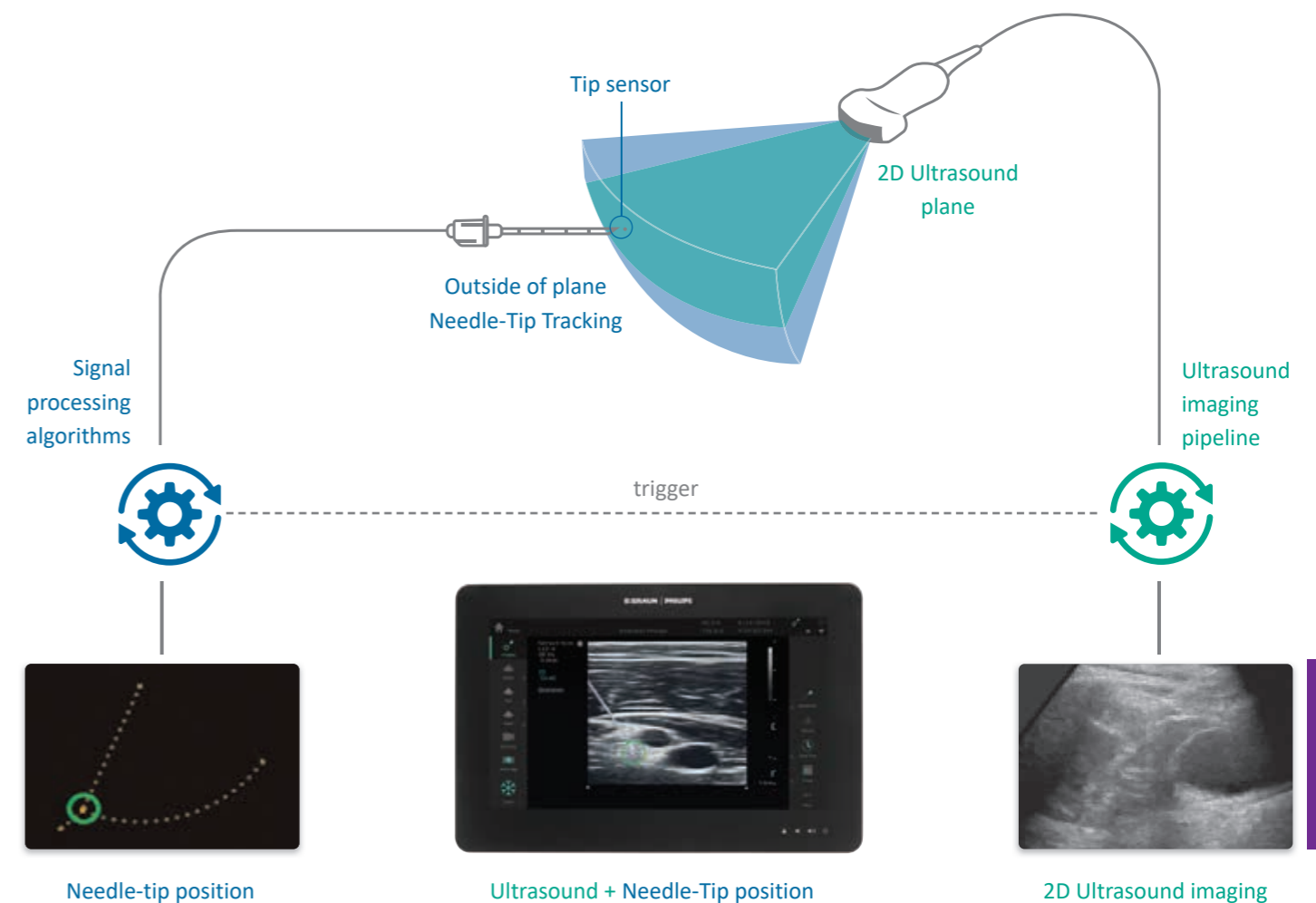

Ultrasound based Technology to improve Accuracy

- Onvision® works up to 12 cm
- Onvision® is shielded against electromagnetic interferences (EMI)
- Onvision® remains accurate even when the needle bends

EZCOVER® – improved protection for patient, user and equipment

Generic Ultrasound Probe Cover Set



EZCOVER®. Because infection control matters.

Infection prevention and control are key priorities in the healthcare setting. Although ultrasound is considered one of the safest imaging modalities, infection transmission risks during ultrasound are evident.¹ The use of a sterile sheath and gel for interventional ultrasound is an important way to prevent cross-contamination and reduce the risk of healthcare-associated infections.²

"Dedicated transducer covers and sterile gel must be used for all interventions"

(Recommendation of the European Society of Radiology Ultrasound Working Group)

ALL SETS INCLUDE:

- Ultrasound probe cover - available in different sizes (W x L)
 - 15 x 30 cm
 - 15 x 61 cm
 - 15 x 122 cm
 - 15 x 244 cm
- Sterile ultrasound gel (1 x 20 g)
- Latex-free rubber fixation bands (2 x)
- Blue sterile drape (40 x 40 cm)

EZCOVER®. Improved protection for patient, user and equipment

EZCOVER® are sterile, latex-free and ensure maximum protection for the patient, the user and the equipment. EZCOVER® are suited to all sterile and non-sterile ultrasound applications.

Easy to fit and convenient to use.

The telescopic folding allows for sterile application. Clear instruction labels on the cover decrease the risk of errors and misuse.

Image quality without compromise.

The high-quality material of the soft sleeve emulates the properties of human tissue. The elastic material facilitates wrinkle and air-free application for distortion free scanning.

EZCOVER® BENEFITS:

IMPROVED PROTECTION

- Latex-free
- Approved for intraoperative use
- Reduces risks of procedural errors (STOP (Check) Sticker)

EASY TO FIT – CONVENIENT TO USE

- Improved handling
- Elastic material – conforms to all probes
- All necessary components for immediate use in one set

ADVANCED PERFORMANCE

- Soft and comfortable material
- Wrinkle and air-free fit
- No compromise in image quality

Stop before you block!

Wrong site blocks (WSB) are classified as never events but they tend to happen frequently.³ A nation-wide patient safety campaign in the UK called "Stop before you block" is aimed at reducing the incidence of inadvertent wrong-sided nerve blocks during regional anesthesia.⁴

EZCOVER® are available with STOP (Check) label. The sticker reminds the practitioner to STOP immediately prior to the start of the procedure and conduct a final confirmation on the right surgery site and side of the block.





BENEFITS:



- Assures compliance with the WHO Checklist (JCI Standards IPSG4 and IPSG.4.1)
- Reduces risks of wrong-sided blocks

Portfolio overview



ULTRASOUND SYSTEM AND ONVISION® TECHNOLOGY

Xperius®	Description	Units per box	Code no. (REF)
Xperius® cart system with 1 transducer L12-4 and Onvision® Needle Tip Tracking technology			
	<ul style="list-style-type: none"> Type of unit: compact cart based Point of Care ultrasound system with Linear L12-4 and Onvision® Technology Dimensions: 132.5 cm x 56.0 cm x 66 cm (H/W/D) Weight: 36.0 kg Display: 39.6 cm (15.6 in) flat-panel touch-screen Imaging mode keys: 2D, Color Doppler, Color Power Angio (CPA), M-Mode 	1	NUSM621
Xperius® cart system with 1 transducer L12-4			
	<ul style="list-style-type: none"> Type of unit: compact cart based Point of Care ultrasound system with fully articulating arm and Linear L12-4 Dimensions: 132.5 cm x 56.0 cm x 66 cm (H/W/D) Weight: 34.0 kg Display: 39.6 cm (15.6 in) flat-panel touch-screen Imaging mode keys: 2D, Color Doppler, Color Power Angio (CPA), M-Mode 	1	NUSM623
Xperius® stand-alone tablet with 1 transducer L12-4			
	<ul style="list-style-type: none"> Type of units: Point of Care tablet ultrasound system with Kickstand and Linear 12-4 Dimensions: 28 cm x 42 cm x 5 cm (H/W/D) Weight: 3.6 kg 	1	NUSM626



PROBE COVER SETS - ULTRASOUND ACCESSORIES

	Description	Size (W x L cm)	Units	Code no.
Generic Set				
	U/S Probe Cover Set w/Gel	15x30	30/Box	PCG15030
	U/S Probe Cover Set w/Gel	15x61	30/Box	PCG15061
	U/S Probe Cover Set w/Gel	15x122	30/Box	PCG15122
	U/S Probe Cover Set w/Gel	15x244	25/Box	PCG15244
Set with STOP (Check)				
	U/S Probe Cover Set, STOP w/Gel	15x30	30/Box	PCT15030
	U/S Probe Cover Set, STOP w/Gel	15x61	30/Box	PCT15061
	U/S Probe Cover Set, STOP w/Gel	15x122	30/Box	PCT15122
	U/S Probe Cover Set, STOP w/Gel	15x244	25/Box	PCT15244

COMPLEMENTARY PRODUCTS

Xperius® Upgrade Items	Description	Units per box	Code no. (REF)
Single transducer linear			
	L12-4 broadband linear array transducer <ul style="list-style-type: none"> 12 to 4 MHz extended operating frequency range Aperture size: 34 mm High resolution imaging for shallow applications Center line marker USB transducer with replaceable cable 	1	FUS5716
Single transducer curved			
	C5-2 broadband curved array transducer <ul style="list-style-type: none"> 5 to 2 MHz extended operating frequency range 50 mm radius of curvature High resolution imaging for deeper applications Center line marker USB transducer with replaceable cable 	1	FUS5712

ONVISION® SINGLE SHOT BLOCK NEEDLES

Stimuplex® Onvision®	Needle ø (G) and Length (inch)	Needle ø and Length (mm)	Units per box	Code no. (REF) Luer
Luer version				
	Insulated needles with 30° bevel			
	22 G x 2"	0.70 x 50 mm	10	4892705-01
	22 G x 3 1/8"	0.70 x 80 mm		4892708-01
	20 G x 4"	0.90 x 100 mm		4892710-01
	20 G x 4 3/4"	0.90 x 120 mm		4892712-01
	20 G x 6"	0.90 x 150 mm		4892715-01
NRFit® version				
	Insulated needles with 30° bevel			
	22 G x 2"	0.70 x 50 mm	10	4892705NR-01
	22 G x 3 1/8"	0.70 x 80 mm		4892708NR-01
	20 G x 4"	0.90 x 100 mm		4892710NR-01
	20 G x 4 3/4"	0.90 x 120 mm		4892712NR-01
	20 G x 6"	0.90 x 150 mm		4892715NR-01



ELASTOMERIC PUMP SYSTEMS

Elastomeric pump systems for post-operative pain therapy with peripheral nerve block or epidural catheters.

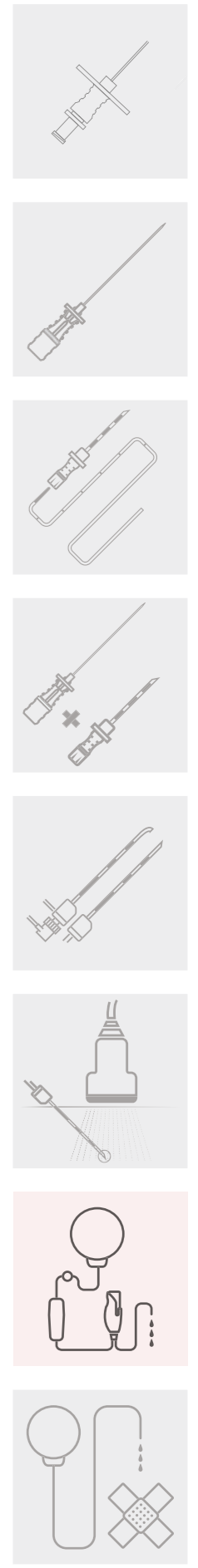

ON-Q® elastomeric pump systems for continuous Regional Anesthesia

USER BENEFITS

- Convenient and strong soft shell design allowing for increased patient comfort
- Reliable and silent infusion without complicated electronics



ON-Q® – pump systems for continuous regional anesthesia

The ON-Q® elastomeric pump system is a pain management solution that has been clinically proven to reduce pain and opioid consumption when used to deliver local anesthetics to or around surgical wound sites or in close proximity to nerves, when compared to narcotic only pain management.²⁴ Patients receiving ON-Q® in combination with the potential benefits of a continuous nerve block can experience faster mobilization and a quicker return to their home environment.^{25,26,27}

A product range with fixed flow rate pumps, Select-A-Flow™ for variable flow rate, and bolus devices allow you to choose

the right pump for a patient individual post operative pain therapy. ON-Q® elastomeric pump systems work without complicated electronics, thus avoiding problems with batteries, maintenance, safety checks. Also, there is no need for complex staff training.

Hospitals or healthcare providers can at the same time benefit from reduced length of stay and increased patient satisfaction.^{28,29}

ON-Q® Bolus



Refill indicator:
Indicates to the patient when the next bolus can be administered.

Safe and simple bolus administration allows the delivery of a continuous fixed basal rate with an additional bolus option for patient adjusted pain relief. Different articles, offering either 30 or 60 min refill time options are available to effectively manage the occurrence of breakthrough pain sensations.

USER BENEFITS

- Ergonomic bolus button design
- Easy to read reservoir fill indicator
- Bolus pump is designed for optimal pain management and incisional applications

Select-A-Flow™



The Select-A-Flow™ controller which is available in two different configurations (1-7 ml/h and 2-14 ml/h), allows flow rate adjustments according to patient individual pain relief requirements.

USER BENEFITS

- Flow rate adjustment in 7 steps
- Rate-changing key may be removed to discourage tampering

Portfolio overview

SINGLE PUMP MODELS (5 UNITS/BOX)

ON-Q® pump	Fill Volume (ml)	Flow Rate (ml/h)	Code no. (REF) Luer	Code no. (REF) NRFit®
	100	2	PS100X2	-
	100	2 (1x1)	PS100X2D	-
	270	2	PS270X2	-
	270	4	PS270X4	-
	270	5	PS270X5	-
	270	4 (2x2)	PS270X4D	-
	400	4	PS400X4	-
	400	5	CBI001	CB001-N
	400	8	PS400X8	P400X8-N
	400	10	CBI002	CB002-N
	400	4 (2x2)	PS400X4D	-

PUMP WITH VARIABLE FLOW RATE SELECTOR + BOLUS BUTTON (5 UNITS/BOX)

ON-Q® pump + Select-A-Flow™ + Bolus button	Fill Volume (ml)	Flow Rate (ml/h)	PCA Bolus Button (ml)	Refill (min)	Code no. (REF) Luer	Code no. (REF) NRFit®
	400	1 - 7	3	30	CB005C	CB005C-N
		2 - 14	3	20	CB006C	CB006C-N

* Contents: Single Use Infusion Pump, carry case, 60 ml filling syringe, Medication label, Peel-Away labels. Filling extension tube – only 400 ml pump models. Each case includes instructions for use.

PUMP WITH BOLUS BUTTON (5 UNITS/BOX)

ON-Q® pump + Bolus button	Fill Volume (ml)	Flow Rate (ml/h)	PCA Bolus Button (ml)	Refill (min)	Code no. (REF) Luer	Code no. (REF) NRFit®
	270	2	3	30	PMB01B	PMB01B-N
	400	5	3	30	CB003B	CB003B-N
	400	5	3	60	CBI003	-

PUMP WITH VARIABLE FLOW RATE SELECTOR (5 UNITS/BOX)

ON-Q® pump + Select-A-Flow™	Fill Volume (ml)	Flow Rate (ml/h)	Code no. (REF) Luer	Code no. (REF) NRFit®
	270	1 - 7	PSAF01	PSAF01-N
	400	2 - 14	CBI004	CB004-N
	600		CBI6004	CB6004-N
	ON-Q® pump + dual Select-A-Flow™			
	400	2 x 1 - 7	CB4007	CB4007-N
	600		-	CB6007-N

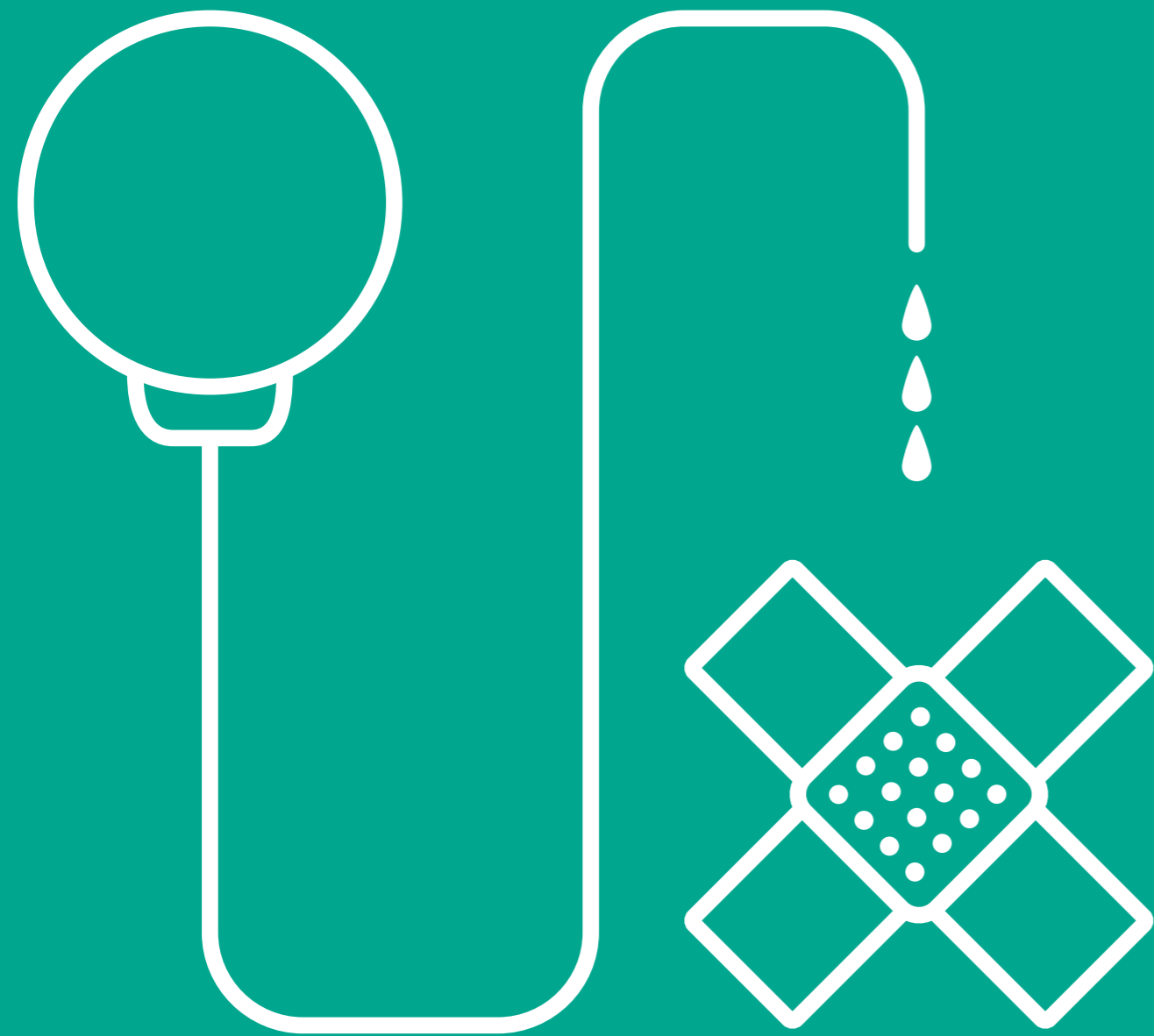

CONTINUOUS WOUND INFUSION

Pain therapy on site –
catheter systems for
continuous wound infusion.

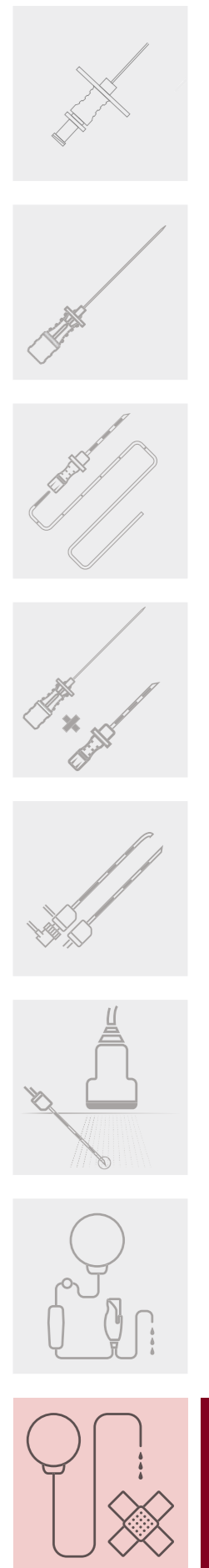

ON-Q® elastomeric pump systems for continuous wound infusion

ON-Q® pain relief system

Continuous wound infusion is a technique that delivers local anesthetic through a multi-hole fenestrated catheter to or near the surgical site for post-operative pain relief.³⁰ It provides an effective postoperative pain management, decreases pain and discourages opioid use.

The simple approach of placing a Soaker Catheter™ to infuse local anesthetic into or near the incisional site can be widely used and offers the potential to provide complete analgesia, while reducing the need of opioids and their associated side effects.²⁴



ON-Q® tunneling system

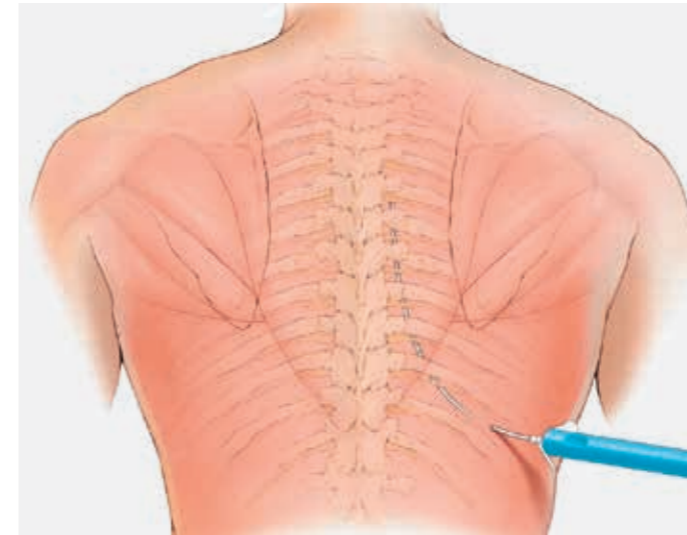

The blunt tunneling system which is provided with a tear-away sheath helps to place the Soaker Catheter™ in the sub-fascia, extra-pleural or intramuscular layers, allowing access to the key nerve bundles.

The Silver Soaker™ catheter comes with an additional silver coating that works as an antimicrobial agent.

ON-Q® Silver Soaker™ catheter with silver-ions-coating on both sides

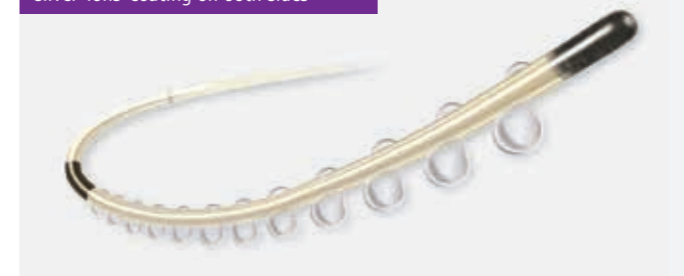

ON-Q® Soaker Catheter™



FEATURES AND USER BENEFITS

- Unique catheter design with multiple lateral holes along the infusion segment
- Easy to use catheter with introducer needle with peel-away sheath
- Length markings for more accurate positioning
- Dual catheter systems available

Portfolio overview

ON-Q® PAIN RELIEF SYSTEMS (5 UNITS/BOX)

ON-Q® Pump	Fill Volume (ml)	Flow Rate (ml/h)	Catheter 2.5 cm				Catheter 6.5 cm				Catheter 12.5 cm				Catheter 25 cm			
			Soaker™ catheter		Silver Soaker™ catheter		Soaker™ catheter		Silver Soaker™ catheter		Soaker™ catheter		Silver Soaker™ catheter		Soaker™ catheter		Silver Soaker™ catheter	
ON-Q® system options			Code no. (REF) Luer	Code no. (REF) NRFit®	Code no. (REF) Luer	Code no. (REF) NRFit®	Code no. (REF) Luer	Code no. (REF) NRFit®	Code no. (REF) Luer	Code no. (REF) NRFit®	Code no. (REF) Luer	Code no. (REF) NRFit®	Code no. (REF) Luer	Code no. (REF) NRFit®	Code no. (REF) Luer	Code no. (REF) NRFit®	Code no. (REF) Luer	Code no. (REF) NRFit®
	100	1	PS2501	-	-	-	-	-	-	-	-	-	-	-	-	-	-	-
	100	2	PS2502	PS2502-N	-	-	PS6502	PS6502-N	PS6502-A	PS6502-A-N	PS12502	PS12502-N	-	-	-	-	-	-
	270	2	-	-	-	-	PS6503	PS6503-N	PS6503-A	-	PS12503	-	-	-	-	-	-	-
	270	5	PS2504	PS2504-N	-	-	PS6504	PS6504-N	PS6504-A	PS6504-A-N	PS12504	PS12504-N	PS12504-A	PS12504-A-N	-	-	-	-
	270	4 (2x2)	-	-	-	-	PS6505	PS6505-N	PS6505-A	-	PS12505	PS12505-N	PS12505-A	PS12505-A-N	PS25005	-	PS25005-A	-
	270	1-7	-	-	-	-	PSAF02	-	-	-	-	-	-	-	-	-	-	-
	400	5	-	-	-	-	PS6506	-	-	-	PS12506	PS12506-N	PS12506-A	PS12506-A-N	PS25006	-	PS25006-A	-
	400	10	-	-	-	-	PS6507	PS6507-N	-	-	PS12507	PS12507-N	-	-	-	-	-	-
	400	4 (2x2)	-	-	-	-	PS6508	PS6508-N	-	-	PS12508	PS12508-N	PS12508-A	-	PS25008	-	PS25008-A	-

Contents: Single use infusion pump, Soaker™ catheter, E-clip or carry case, 60 ml filling syringe, Medication label, Peel-Away labels, 17 GA T-peel introducer and sheath, 5 ml priming syringe, Filling extension set - only 400 ml pump models. Each case includes instructions for use.

ON-Q® EXPANSION KITS (5 UNITS/BOX)

Catheter	Length (cm)	Soaker™ Catheter		Silver Soaker™ Catheter	
		Code no. (REF) Luer	Code no. (REF) NRFit®	Code no. (REF) Luer	Code no. (REF) NRFit®
	2.5	PM030	PM030-N	PM030-A	-
	6.5	PM010	PM010-N	PM010-A	PM010-A-N
	12.5	PM020	PM020-N	PM020-A	PM020-A-N
	19.1	-	PM050-N	PM050-A	PM050-A-N
	25	PM040	PM040-N	PM040-A	PM040-A-N

Contents: Soaker™/SilverSoaker™ Catheter, T-peel needle(s), 5ml priming syringe, Tegaderm™ and Steri-Strips™. Each case includes instructions for use.

ACCESSORIES

ON-Q® Accessories	Length (cm)	Ø (Gauge)	Units per box	Code no. (REF)
Soaker™ introducer needle	8.3	-	10	ACC01
	15.2	-		ACC02
	20.3	-		ACC03
Filling extension set	-	-	5	ACC05
Introducer Sheath	20.3	17	5	ACC08S
	30.5	16		ACC10S
	20.3	11		ACC07S
	30.5	11		ACC09S

ON-Q® DISPOSABLE TUNNELERS

Tunnelers	Length (cm)	Ø (Gauge)	Units per box	Code no. (REF)
	20.3	11	5	T11X8
	30.5	11		T11X12
	25	11		T11X10
	30.5	16		T16X12
	12.5	17		T17X5
	20.3	17		T17X8
	25	17		T17X10
	Fluid tunneler	20.3		11
30.5		11	FT11X12	
20.3		16	FT16X8	
30.5		16	FT16X12	

Contents: Tunneler and two disposable sheaths. Each case includes instructions for use.

B. Braun Medical B.V. | +31 (0)412 67 24 11 | customer care.nl@bbraun.com | www.bbraun.nl

NRFit® is a federally registered trademark of GEDSA in multiple jurisdictions throughout the world. Used with permission.
ENFit® is a trademark of GEDSA. Used with permission.

The information contained in this communication is strictly confidential, may constitute inside information, and is intended only for the use of the addressee. It is the property of the sender of this information. Unauthorized use, disclosure, or copying of this communication or any part thereof is strictly prohibited and may be unlawful.

