



WE UNDERSTAND.



NEUROSURGERY

ACCESSORIES FOR MIETHKE SHUNT SYSTEMS

ACCESSORIES

CATHETERS

- All catheters are made of radio-paque silicone

$d_i = 1.2 \text{ mm}$

$d_o = 2.5 \text{ mm}$

PERITONEAL CATHETERS, BARIUM-IMPREGNATED



Art. no.	Length
FV070P	600 mm
FV071P	900 mm
FV072P	1200 mm

PERITONEAL CATHETER WITH INTEGRATED BARIUM STRIP



Art. no.	Length
FV091P	900 mm
FV090P	1200 mm

VENTRICULAR CATHETER WITH INTRODUCING STYLET, GRADUATED, BARIUM-IMPREGNATED, 8 BORES (16 HOLES)



Art. no.	Length
FV074P	180 mm
FV077P	250 mm

- All catheters are made of radio-paque silicone

$d_i = 1.2 \text{ mm}$
 $d_o = 2.5 \text{ mm}$

- Design acc. Dr. Thomale

Deflector:

- With suture fixation hole
- Made of titanium
- Radiopaque
- Allows 90° deflection of the ventricular catheter in the burrhole without kinking the catheter
- Adjustable on catheter
- Allows precise setting of the penetration depth of the ventricular catheter prior to implantation

THOMALE KATHETER WITH STYLET, GRADUATED, BARIUM-IMPREGNATED, 3 BORES (6 HOLES)



Art. no.	Length
FV093P	180 mm

VENTRICULAR CATHETER WITH DEFLECTOR

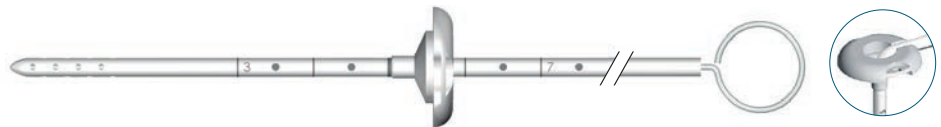

Art. no.	Set
FV075P	<ul style="list-style-type: none"> ▪ Ventricular catheter, 180 mm, with stylet, graduated ▪ Deflector, large, 16 mm
FV078P	<ul style="list-style-type: none"> ▪ Ventricular catheter, 250 mm, with stylet, graduated ▪ Deflector, large, 16 mm



Art. no.	Set
FV076P	<ul style="list-style-type: none"> ▪ Ventricular catheter, 180 mm, with stylet, graduated ▪ Deflector, small, 13 mm

ACCESSORIES

DEFLECTORS

- With suture fixation hole
- Made of titanium
- Radiopaque
- Allows 90° deflection of the ventricular catheter in the burrhole without kinking the catheter
- Adjustable on catheter

DEFLECTORS



16 mm



9.5 mm

Art. no.	Deflector
FV010T	large, 16 mm



13 mm



3 mm

Art. no.	Pediatric deflector
FV011T	small, 13 mm

PORTS

- Made of titanium
- Radiopaque
- Low overall height for easy and reliable positioning and fixation of the ventricular catheter
- Allows CSF extraction and drug injection by inserting a syringe through the silicone dome
- Solid titanium base preventing penetration with a syringe needle

BURRHOLE PORTS

FV030T:

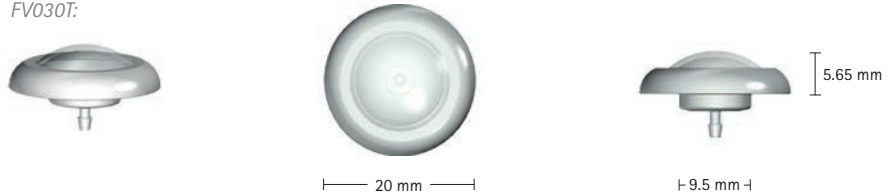

FV040T:



Art. no.	Ports
FV030T	large, 20 mm
FV040T	small, 14 mm

PORT SET



Art. no.	Set
FV042T	<ul style="list-style-type: none"> ▪ Port, small, 14 mm ▪ Ventricular catheter, 180 mm, with stylet, graduated

Connector: $d_o = 1.9 \text{ mm}$
 Catheter: $d_i = 1.2 \text{ mm}$, $d_o = 2.5 \text{ mm}$

ACCESSORIES

PORTS

- Made of titanium
- Radiopaque
- Low overall height for easy and reliable positioning and fixation of the ventricular catheter
- Allows CSF extraction and drug injection by inserting a syringe through the silicone dome
- Solid titanium base preventing penetration with a syringe needle

CSF-PORT

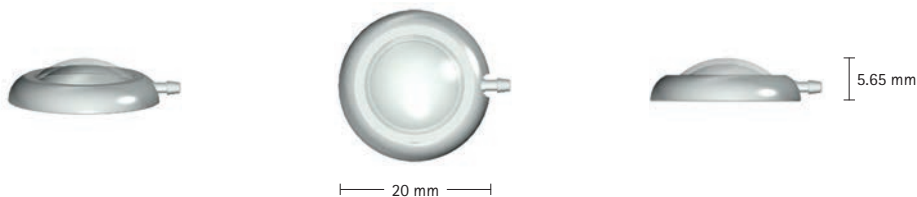

Art. no.	CSF-Port
FV060T	large, 20 mm

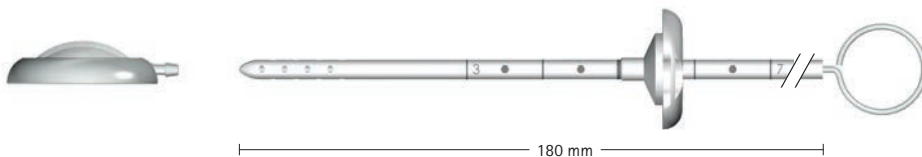

Art. no.	Set
FV062T	<ul style="list-style-type: none"> ▪ CSF-Port, large, 20 mm ▪ Ventricular catheter, 180 mm, with stylet, graduated ▪ Deflector, large, 16 mm

Connector: $d_o = 1.9 \text{ mm}$

Catheter: $d_i = 1.2 \text{ mm}$, $d_o = 2.5 \text{ mm}$

BURRHOLE RESERVOIR

- Made of titanium
- Radiopaque
- Low overall height for easy and reliable positioning and fixation of the ventricular catheter
- Allows CSF extraction and drug injection by inserting a syringe through the silicone dome
- Solid titanium base preventing penetration with a syringe needle
- A pediatric Burrhole Reservoir is also available, it is adapted to the size of a child's skull

BURRHOLE RESERVOIR

FV028T:



FV029T:



FV039T:



FV027T:



FV054T:

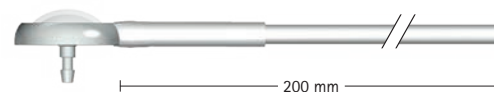

Art. no.	Burrhole Reservoir
FV028T	large, 20 mm
FV029T	ETOU Reservoir, large, 20 mm, with adjustable connector
FV039T	small, 14 mm
FV027T	large, 20 mm, with catheter, 600 mm
FV054T	small, 14 mm, with catheter, 200 mm

Connector: $d_o = 1.9 \text{ mm}$
 Catheter: $d_i = 1.2 \text{ mm}$, $d_o = 2.5 \text{ mm}$

ACCESSORIES

BURRHOLE RESERVOIR

- Made of titanium
- Radiopaque
- Low overall height for easy and reliable positioning and fixation of the ventricular catheter
- Allows CSF extraction and drug injection by inserting a syringe through the silicone dome
- Solid titanium base preventing penetration with a syringe needle

BURRHOLE RESERVOIR SET

FV032T:

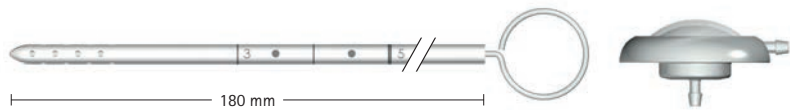

FV031T:

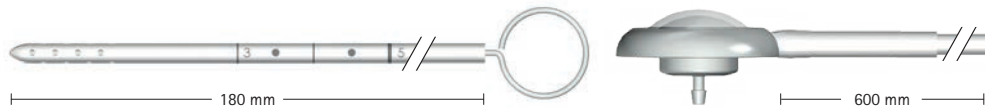

Art. no.	Set
FV032T	<ul style="list-style-type: none"> ▪ Burrhole Reservoir, large, 20 mm ▪ Ventricular catheter, 180 mm, with stylet, graduated
FV031T	<ul style="list-style-type: none"> ▪ Burrhole Reservoir, large, 20 mm, with catheter, 600 mm ▪ Ventricular catheter, 180 mm, with stylet, graduated

FV041T:

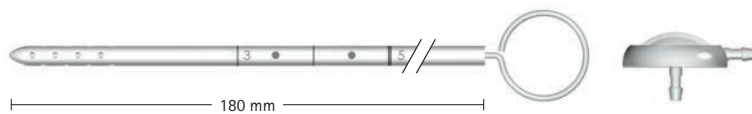

FV055T:

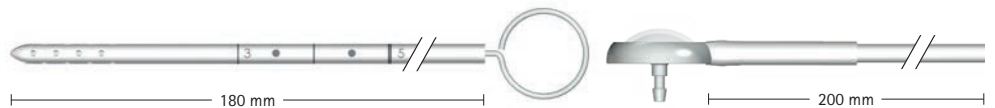

Art. no.	Set
FV041T	<ul style="list-style-type: none"> ▪ Burrhole Reservoir, small, 14 mm ▪ Ventricular catheter, 180 mm, with stylet, graduated
FV055T	<ul style="list-style-type: none"> ▪ Burrhole Reservoir, small, 14 mm, with catheter, 200 mm ▪ Ventricular catheter, 180 mm, with stylet, graduated

Connector: $d_o = 1.9 \text{ mm}$
 Catheter: $d_i = 1.2 \text{ mm}$, $d_o = 2.5 \text{ mm}$

McLANAHAN RESERVOIR

- Made of titanium
- Radiopaque
- Allows checking the patency of both the ventricular catheter and the distal catheter
- Allows for CSF extraction and controlled drug injection into the ventricles
- Integrated mechanism shutting off the proximal connection to the ventricular catheter during pumping
- Integrated mechanism shutting off the distal connection during injection with syringe needle
- Design acc. to Dr. McLanahan

McLANAHAN RESERVOIR

FV082T:



Art. no.	McLANAHAN RESERVOIR
FV082T	large, 20 mm

Connector: $d_o = 1.9 \text{ mm}$

ACCESSORIES

SPRUNG RESERVOIR

- Made of titanium
- Radiopaque
- Allows checking the patency of both the ventricular catheter and the distal catheter
- Solid titanium base preventing penetration with a syringe needle
- Integrated mechanism shutting off the proximal connection to the ventricular catheter during pumping
- Design acc. to Dr. Sprung

Mechanism:

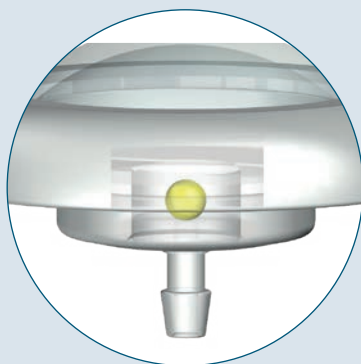

Connector: $d_o = 1.9 \text{ mm}$
 Catheter: $d_i = 1.2 \text{ mm}$, $d_o = 2.5 \text{ mm}$

SPRUNG RESERVOIR

FV043T:



FV044T:



Art. no.	SPRUNG RESERVOIR
FV043T	large, 20 mm
FV044T	large, 20 mm, with catheter, 600 mm

SPRUNG RESERVOIR SET

FV045T:

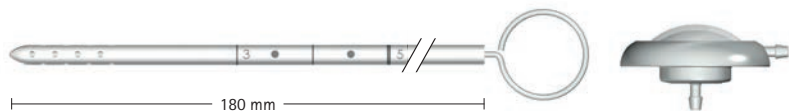

FV046T:

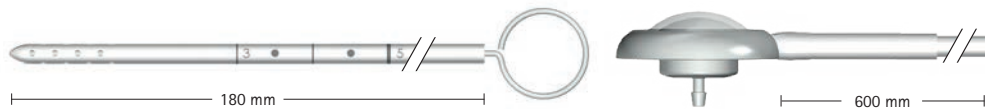

Art. no.	Set
FV045T	<ul style="list-style-type: none"> ▪ <i>SPRUNG RESERVOIR</i>, large, 20 mm ▪ Ventricular catheter, 180 mm, with stylet, graduated
FV046T	<ul style="list-style-type: none"> ▪ <i>SPRUNG RESERVOIR</i>, large, 20 mm, with catheter, 600 mm ▪ Ventricular catheter, 180 mm, with stylet, graduated

PEDIATRIC SPRUNG RESERVOIR

- Made of titanium
- Radiopaque
- Allows checking the patency of both the ventricular catheter and the distal catheter
- Solid titanium base preventing penetration with a syringe needle
- Integrated mechanism shutting off the proximal connection to the ventricular catheter during pumping
- Design acc. to Dr. Sprung
- Adapted to the size of a child's skull

Mechanism:

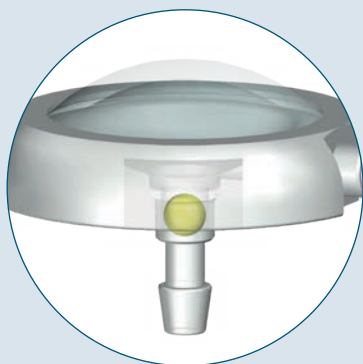

Connector: $d_o = 1.9 \text{ mm}$
 Catheter: $d_i = 1.2 \text{ mm}$, $d_o = 2.5 \text{ mm}$

PEDIATRIC SPRUNG RESERVOIR

FV063T:

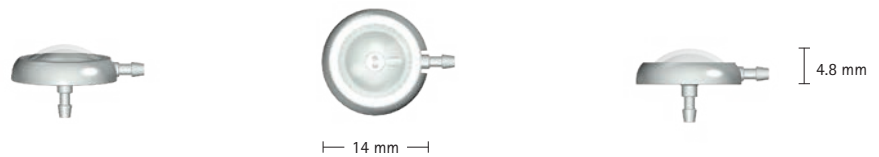

FV064T:

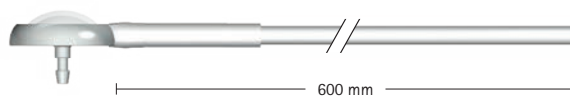

Art. no.	Pediatric SPRUNG RESERVOIR
FV063T	small, 14 mm
FV064T	small, 14 mm, with catheter, 600 mm

PEDIATRIC SPRUNG RESERVOIR SET

FV065T:

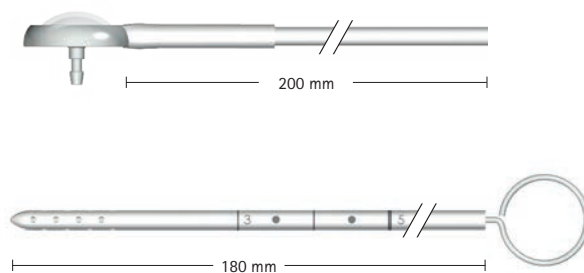

Art. no	Set
FV065T	<ul style="list-style-type: none"> ▪ pediatric SPRUNG RESERVOIR, small, 14 mm, with catheter, 200 mm ▪ Ventricular catheter, 180 mm, with stylet, graduated

ACCESSORIES

CONTROL RESERVOIR

- Made of titanium
- Radiopaque
- Allows CSF extraction and drug injection by inserting a syringe through the silicone dome
- Allows checking the patency of both the ventricular catheter and the distal catheter
- Solid titanium base preventing penetration with a syringe needle
- Integrated valve mechanism shutting off the proximal connection to the ventricular catheter during pumping

Mechanism:

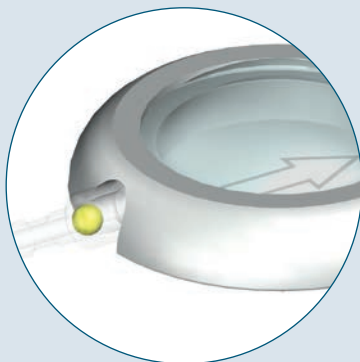

Connector: $d_o = 1.9 \text{ mm}$
Catheter: $d_i = 1.2 \text{ mm}$, $d_o = 2.5 \text{ mm}$

CONTROL RESERVOIR

FV047T:

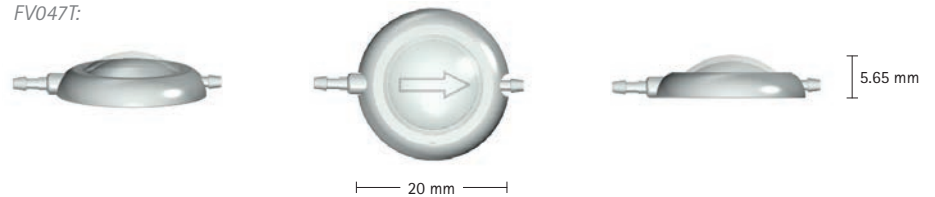

FV048T:



Art. no.	CONTROL RESERVOIR
FV047T	large, 20 mm
FV048T	large, 20 mm, with catheter, 600 mm

CONTROL RESERVOIR SET

FV049T:

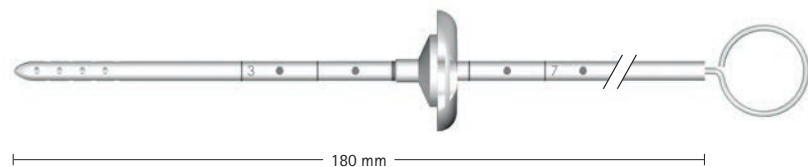

Art. no.	Set
FV049T	<ul style="list-style-type: none"> ▪ CONTROL RESERVOIR, large, 20 mm, with catheter, 600 mm ▪ Ventricular catheter, 180 mm, with stylet, graduated, deflector, large, 16 mm

PEDIATRIC CONTROL RESERVOIR

- Made of titanium
- Radiopaque
- Allows CSF extraction and drug injection by inserting a syringe through the silicone dome
- Allows checking the patency of both the ventricular catheter and the distal catheter
- Solid titanium base preventing penetration with a syringe needle
- Integrated valve mechanism shutting off the proximal connection to the ventricular catheter during pumping
- Adapted to the size of a child's skull

Mechanism:

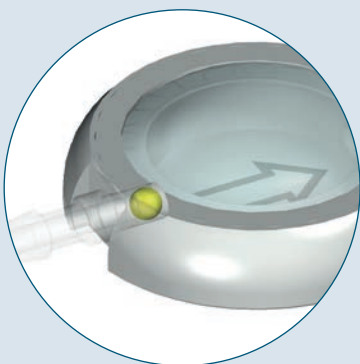

Connector: $d_o = 1.9 \text{ mm}$
 Catheter: $d_i = 1.2 \text{ mm}$, $d_o = 2.5 \text{ mm}$

PEDIATRIC CONTROL RESERVOIR

FV066T:

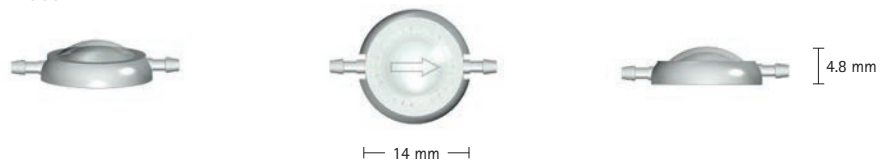

FV067T:



Art. no.	Pediatric CONTROL RESERVOIR
FV066T	small, 14 mm
FV067T	small, 14 mm, with catheter, 600 mm

PEDIATRIC CONTROL RESERVOIR SET

FV068T:

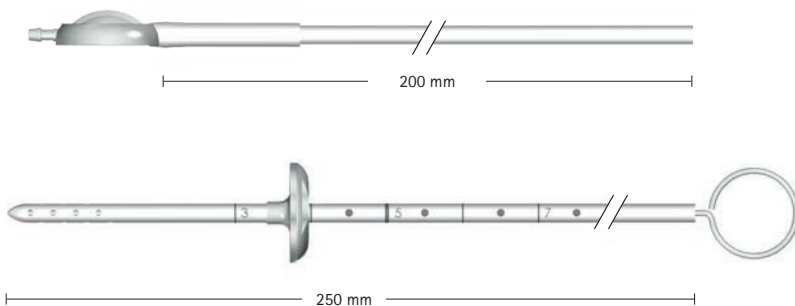

Art. no.	Set
FV068T	<ul style="list-style-type: none"> ▪ pediatric CONTROL RESERVOIR, small, 14 mm, with catheter, 200 mm ▪ Ventricular catheter, 250 mm, with stylet, graduated with pediatric deflector, small, 13 mm

ACCESSORIES

PRECHAMBER

- Made of titanium
- Radiopaque
- Allows CSF extraction and drug injection by inserting a syringe through the silicone dome
- Solid titanium base preventing penetration with a syringe needle

PRECHAMBER

FV033T:

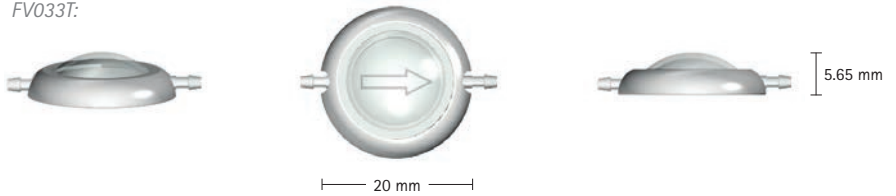

FV035T:

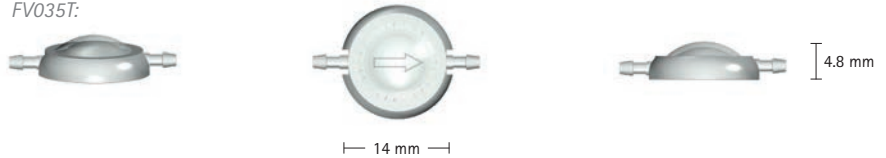

FV034T:



Art. no.	Prechamber
FV033T	large, 20 mm
FV035T	small, 14 mm
FV034T	large, 20 mm, with catheter, 600 mm

Connector: $d_o = 1.9$ mm

Catheter: $d_i = 1.2$ mm, $d_o = 2.5$ mm

- Made of titanium
- Radiopaque
- Allows CSF extraction and drug injection by inserting a syringe through the silicone dome
- Solid titanium base preventing penetration with a syringe needle

PRECHAMBER SET

FV036T:

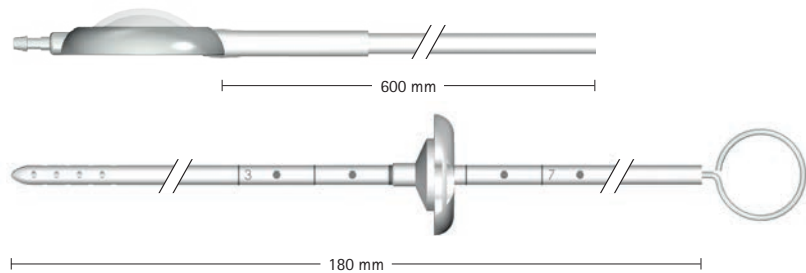

FV037T:

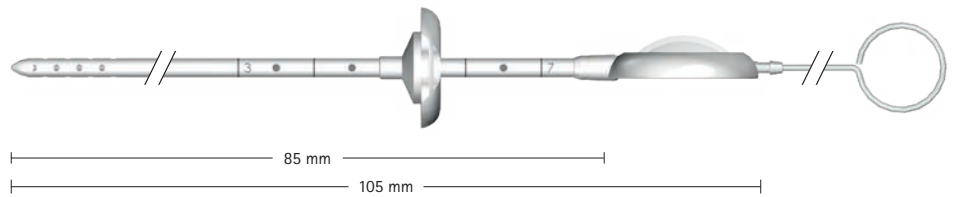

FV079T:

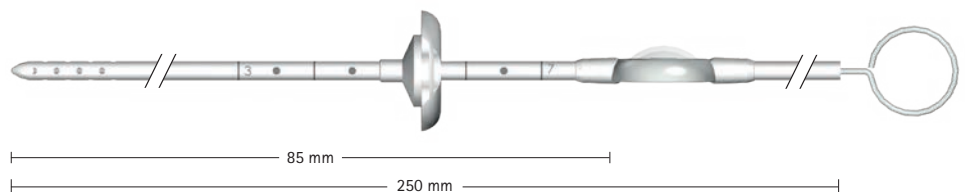

Art. no.	Set
FV036T	<ul style="list-style-type: none"> ▪ Ventricular catheter, 180 mm, with stylet, graduated ▪ Prechamber, large, 20 mm, with catheter, 600 mm ▪ Deflector, large, 16 mm
FV037T	<ul style="list-style-type: none"> ▪ Ventricular catheter, 85 mm, graduated, and integrated prechamber, large, 20 mm and stylet ▪ Deflector, large, 16 mm
FV079T	<ul style="list-style-type: none"> ▪ Ventricular catheter, 85 mm, graduated, and integrated prechamber, small, 14 mm with distal catheter, 153 mm and stylet ▪ Deflector, large, 16 mm

Connector: $d_o = 1.9$ mm
 Catheter: $d_i = 1.2$ mm, $d_o = 2.5$ mm

ACCESSORIES

PRECHAMBER

- Made of titanium
- Radiopaque
- Allows CSF extraction and drug injection by inserting a syringe through the silicone dome
- Solid titanium base preventing penetration with a syringe needle

PRECHAMBER SET

FV038T/FV080T:

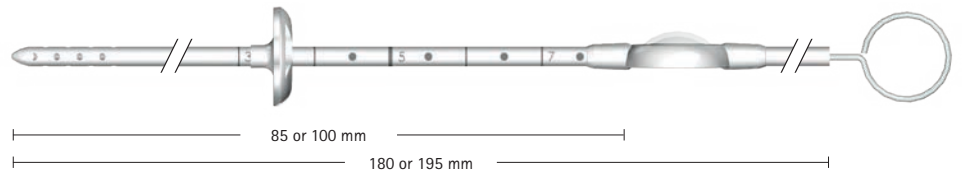

Art. no.	Set
FV038T	<ul style="list-style-type: none">▪ Ventricular catheter, 85 mm, graduated, and integrated prechamber, small, 14 mm with catheter, 80 mm and stylet▪ Deflector, small, 13 mm
FV080T	<ul style="list-style-type: none">▪ Ventricular catheter, 100 mm, graduated, and integrated prechamber, small, 14 mm with catheter, 80 mm and stylet▪ Deflector, small, 13 mm

Connector: $d_o = 1.9$ mm

Catheter: $d_i = 1.2$ mm, $d_o = 2.5$ mm

TITANIUM CONNECTORS









- Preferably for use with catheters of:

- internal diameter
 $d_i = 1.2 \text{ mm}$

- external diameter
 $d_o = 2.5 \text{ mm}$

- Connector diameter:
 $d_o = 1.9 \text{ mm}$

TITANIUM CONNECTORS

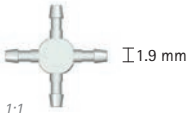
		Straight	Art. no.	Sales unit
	 1:1		FV012T	1 pc.
			FV013T	5 pcs.
			FV014T	10 pcs.
		L-shape	Art. no.	Sales unit
	 1:1		FV051T	1 pc.
		Y-shape	Art. no.	Sales unit
	 1:1		FV015T	1 pc.
			FV016T	5 pcs.
			FV017T	10 pcs.
		T-shape	Art. no.	Sales unit
	 1:1		FV018T	1 pc.
			FV019T	5 pcs.
			FV020T	10 pcs.
		X-shape	Art. no.	Sales unit
	 1:1		FV021T	1 pc.

ACCESSORIES

MAGRAM CONNECTORS

- Preferably for use with catheters of:







- internal diameter
 $d_i = 1.2 \text{ mm}$

- external diameter
 $d_o = 2.5 \text{ mm}$

- Connector diameter:
 $d_o = 1.9 \text{ mm}$

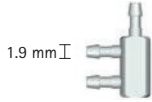
- Design acc. to Dr. Magram

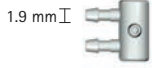

MAGRAM CONNECTORS

	Y-shape	Art. no.	Sales unit
	 1:1	FV056T	1 pc.
	F-shape	Art. no.	Sales unit
	 1:1	FV058T	1 pc.
	L-shape	Art. no.	Sales unit
	 1:1	FV059T	1 pc.
	Sealing plugs	Art. no.	Sales unit
	 1:1	FV024T	1 pc.
		FV025T	5 pcs.
		FV026T	10 pcs.

TITANIUM CONNECTORS

- Step-down connectors are designed for connecting standard catheters to lumbar catheters
- Step-down connector diameters: $d_0 = 1.9 \text{ mm}$ to 1.4 mm

TITANIUM CONNECTORS, STEP-DOWN

	Straight	Art. no.	Sales unit
	 $1.9 \text{ mm} \perp \perp 1.4 \text{ mm}$ 1:1	FV050T	1 pc.

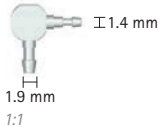
	L-shape	Art. no.	Sales unit
	 1.9 mm 1.4 mm 1:1	FV052T	1 pc.

- L-P connectors are designed for connecting two lumbar catheters
- Connector diameters for L-P drainage: $d_0 = 1.4 \text{ mm}$

TITANIUM CONNECTOR, L-P DRAINAGE

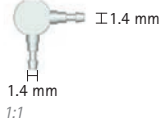
	L-shape	Art. no.	Sales unit
	 1.4 mm 1:1	FV053T	1 pc.

ACCESSORIES

TUNNELING INSTRUMENTS

- For percutaneous tunneling and inserting of catheters

REUSABLE TUNNELING INSTRUMENT, CURVED



Art. no.	Length
FV001R	working length 130 mm, 5 1/8"







- For percutaneous tunneling and inserting of catheters

SINGLE USE TUNNELING INSTRUMENT, FLEXIBLE
 SALES UNIT: PAK= PACKAGE OF 10 PIECES,
 EACH IN INDIVIDUAL STERILE PACKAGING

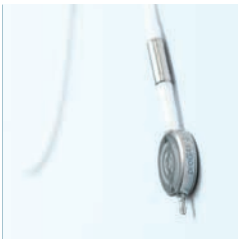

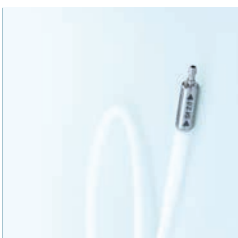
Art. no.	Length
FV002R	300 mm, 11 3/4"
FV003R	450 mm, 17 3/4"
FV004R	600 mm, 23 5/8"

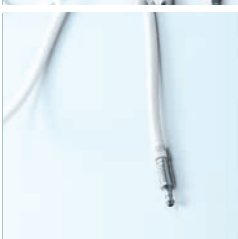
OUR SHUNT SYSTEMS – YOUR CHOICE

proSA®	proGAV® 2.0	GAV® 2.0	SHUNT-ASSISTANT® 2.0	DUALSWITCH Valve	miniNAV®	Accessories
						

Description

Adjustable gravita-tional pressure differential pressure valve	Adjustable differen-tial pressure valve with gravitational unit	Gravitational valve for treating Hydrocephalus	Gravitational valve to prevent overdrainage complications	Gravitational valve with large flow volumes for CSF	Differential pressure valve, specifically for premature babies and newborns or bedrid-den or non-mobile patients
--	---	--	---	---	--

Indication

LP		✓	✓	✓	
NPH	✓	✓	✓	✓	
Pediatric HC	✓	✓	✓		✓
Adult HC	✓	✓	✓	✓	✓

Patient

Lying	✓	✓	✓		✓
Active	✓	✓	✓	✓	*

Feature

3-Tesla MR Conditional	✓	✓	✓	✓	✓
Gravitational Unit	✓	✓	✓	✓	
Adjustable	✓	✓			

* in combination with SHUNTASSISTANT® 2.0 or proSA®



NEUROSURGERY

WE UNDERSTAND THE GRAVITY OF THE SITUATION.

GRAVITATIONAL VALVES BY MIETHKE

AESCULAP® – a B. Braun brand

Aesculap AG | Am Aesculap-Platz | 78532 Tuttlingen | Germany | www.aesculap.com



NEUROSURGERY

SENSOR RESERVOIR

SENSOR PRECHAMBER

TELEMETRIC SHUNT CONTROL – READING INNER VALUES

AESCLAP® – a B. Braun brand

Aesculap AG | Am Aesculap-Platz | 78532 Tuttlingen | Germany | www.aesculap.com

Manufacturer acc. MDD 93/42/EEC

■ **CHRISTOPH MIETHKE GMBH & CO. KG**

Christoph Miethke GmbH & Co. KG | Ulanenweg 2 | 14469 Potsdam | Germany
Phone +49 331 62083-0 | Fax +49 331 62083-40 | www.miethke.com

AESCULAP[®] – a B. Braun brand

Distributed by

Aesculap AG | Am Aesculap-Platz | 78532 Tuttlingen | Germany
Phone +49 7461 95-0 | Fax +49 7461 95-2600 | www.aesculap.com

The product trademarks "GAV", "miniNAV", "proGAV", "proSA" and "SHUNTASSISTANT" are registered trademarks of Christoph Miethke GmbH & Co. KG.

The main product trademark "Aesculap" is a registered trademark of Aesculap AG.

Subject to technical changes. All rights reserved. This brochure may only be used for the exclusive purpose of obtaining information about our products. Reproduction in any form partial or otherwise is not permitted.